

2318

March  
1985

elektor

INDIA

Rs. 7.50

# electronics

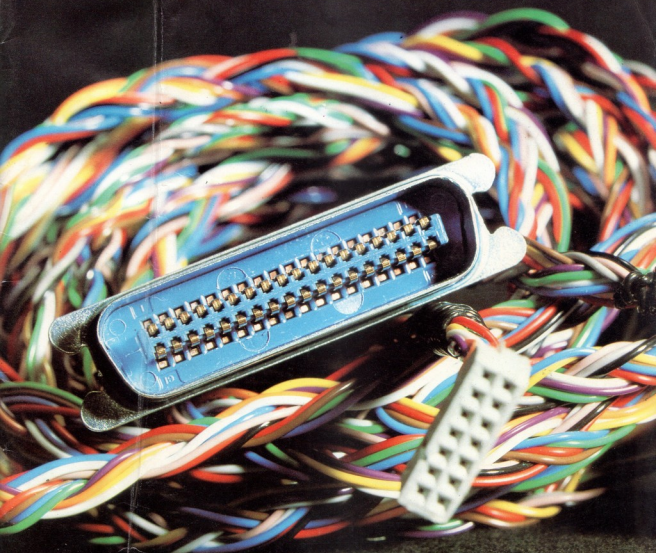

- **EPROM switchboard**
- **RLC meter** ● **easy music**
- **electronics the easiest way**

Introducing the Top-of-the-Line  
Stereo Cassette Tape Deck with Dolby\* NR,  
Metal Tape Facility and Soft Touch Controls:  
**SONODYNE D-700**

Exceptional features at a mini price!



Sonodyne's in-depth experience in hi-fi technology pays off again. In the form of this new top-of-the-line Stereo Cassette Tape Deck: D-700. With incredible built-in features and luxury credentials like high performance, sleek styling, convenience and versatility.

**Highlights of D-700:**

- Slow eject type cassette door and soft-touch push-button controls
- Heavy duty Japanese tape deck mechanism to reduce wow and flutter
- Dolby\* noise reduction circuitry
- Tape selector facility for using Normal, Chromium Dioxide and Metal tapes
- Sendust head for metal composition tapes
- Double LED VU meter

Sonodyne's D-700 is its own spokesman. Switch it on at your nearest Sonodyne dealer. It won't take you long to find out it's the best value cassette deck in the market!

**SONODYNE**  
The name that's music to your ears.

\*Dolby is the registered trademark of Dolby Laboratories, Licensing Corporation.

# elektor contents

## Volume 3-Number 3

EDITOR: SURENDRA IYER  
PUBLISHER: C. R. CHANDARANA  
PRODUCTION: C. N. MITHAGARI

ADVERTISING & SUBSCRIPTIONS  
ELEKTOR ELECTRONICS PVT Ltd.  
Chotani Building  
52 C, Proctor Road Grant Road (E)  
Bombay-400 007.

DISTRIBUTORS: INDIA BOOK HOUSE

PRINTED AT:  
TRUPTI OFFSET  
103, Vasani Udyog Bhavan,  
Off Tulsi Pipe Road,  
Lower Parel, BOMBAY-400 013.

Elektor India is published monthly under agreement with Elektuur B.V. Holland, August/September is a double issue.

### SUBSCRIPTION

#### INLAND

1 Yr Rs. 75/- 2 Yrs Rs. 140/- 3 Yrs Rs. 200/-

#### FOREIGN

One Year Only

Surface mail Rs. 125/- Air mail Rs. 210/-

The Circuits are for domestic use only. The submission of designs, or articles to Elektor India implies permission to the publishers to alter and translate the text and design, and to use the contents in other Elektor publications and activities. The publishers cannot guarantee to return any material submitted to them. All drawings, photographs, printed circuit boards and articles published in Elektor India are copyright and may not be reproduced or imitated in whole or part without prior written permission of the publishers.

Patent protection may exist in respect of circuits, devices, components etc. described in this magazine.

The publishers do not accept responsibility for failing to identify such patent or other protection.

### INTERNATIONAL EDITIONS EDITOR: P. HOLMES

Dutch edition: Elektuur b.v.  
6190 AB Beek (L),  
the Netherlands  
German edition: Elektor Verlag GmbH,  
5133 Gangelt, W-Germany  
English edition: Elektor Publishers Ltd,  
Elektor House, 10 Longport,  
Canterbury CT1 1PE, Kent, U.K.  
French edition: Elektor Sari, Le Seau,  
59270 Baillieux, France  
Italian edition: Elektor, 20082 Conselice B, Italy  
Spanish edition: Elektor, Av. Alfonso XIII,  
141, Madrid 16.  
Greek edition: Elektor, Karaiskaki 14, Voula,  
Athens.  
Turkish edition: Elektor Yayincilik ve Ticaret A.S.,  
Karakoy Istanbul  
Portuguese edition: Ferreira and Bento Lda  
R.D. Estefania 32, 1000 Lisboa  
Protugal

COPYRIGHT © ELEKTUUR B.V. —  
THE NETHERLANDS 1984

electronics the easiest way .....	3-12
It is well known that children can generate some of the most original ideas on any subject. We can only envy the straight-forward simplicity of their answers to questions of a technical nature, especially when the subject is electronics....	
news, views, people .....	3-15
selektor .....	3-17
2000 kW under the seal	
gyroflash .....	3-20
An inventive design comprising five xenon tubes flashing sequentially which has possible applications in photography, scale modelling, or as a distress light, to name but a few.	
1.2 GHz input stage .....	3-24
Designed primarily for our recently published $\mu$ P-controlled frequency meter, this wide-band input stage can also be used with other designs.	
microphone preamplifier .....	3-30
Dual circuit for improved signal-to-noise ratio, more effective hum suppression, and symmetrical signal transfer.	
remote model control by microcomputer .....	3-32
A look at some of the new pcm equipment now becoming available from European and Japanese manufacturers.	
DIY connector .....	3-39
The solution to the eternal problem of what to do when a project you are building needs a special connector, or simply one you do not have. The answer? Look in your junk box!	
programmable rhythm box .....	3-40
Set your microcomputer to work on a useful (7) task: controlling an electronic drum box. The ZX81 is used as an example to show that even small computers can be used for control purposes.	
EPROM selector .....	3-46
A simple way of expanding the memory of your microcomputer.	
easy music .....	3-49
RLC meter .....	3-50
A universal tester of resistance, capacitance, and inductance, which is simple to build, inexpensive, and yet quite accurate. The use of high-quality components makes an accuracy of 1 per cent possible.	
programmable keyboard encoder .....	3-56
This versatile static 80-key matrix can be used for most applications where an alphanumeric keyboard encoder is required.	
applicator .....	3-60
Digital graphic equalizer based on National Semiconductor's LMC835.	
market .....	3-62
switchboard .....	3-69
missing link .....	3-72
index of advertisers .....	3-74

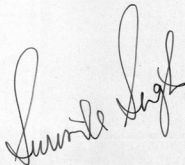

G-200 / R3278

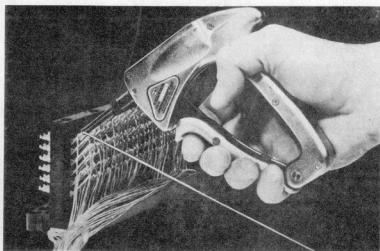

## MANUAL WIRE-WRAPPING TOOLS

### CHUCK TYPE

The G-100/R3278 and G-200/R3278 tools are designed with a chuck nose piece to make use of the full line of bits and sleeves made for power tools. These tools accommodate wire sizes from AWG22 (0.65 mm) thru AWG32 (0.20 mm) and can provide a maximum of ten turns. Fewer wraps can be achieved by adjusting the "strip" length of the wire. For production and field service use in the electronic, telecommunications, and appliances industries.

When wire-wrapping on 025" x 025" (0.63 x 0.63mm) posts use maximum "strip length" of 7/8" (22 mm).

SEE CHARTS ON PAGES 70 AND 71 FOR PROPER SLEEVES AND BITS TO USE WITH THESE TOOLS \*



**OK MACHINE AND TOOL CORPORATION**  
3484 CORNER STREET, BROOKLYN, NEW YORK, N.Y. 11210 U.S.A. • PHONE (212) 864-6800  
TELEX: 232795 TELEFAX: 12 5091

AVAILABLE UNDER OGL APPENDIX No. 1 PART B

#### CONTACT

### BALAJI ENGINEERING CO.

195, Brigade Road  
Bangalore-560 001

Phone : 52411

#### BRANCH

### BALAJI ENTERPRISES,

B-15, Prashanth Apartments,  
Macintyre Road,

Secunderabad-500 003. Phone : 77490

### Mr. S. M. LIMDI

Krishna Krupa  
10th Khetwadi Lane  
Bombay - 400 004 Phone - 389457

MYSORE: Phone - 27737



## MEASUREMENTS MADE EASY



Measurement of INDUCTANCE, CAPACITANCE, RESISTANCE are greatly simplified by VLCR 7.

Connect the component to the terminals. VLCR 7 gives you directly the digital reading of value and its loss factor simultaneously.

FOUR TERMINAL measurement eliminates inherent errors due to lead resistance. GUARD TERMINAL provided eliminates errors due to lead capacitance.

VLCR 7 is the only instrument in India covering the widest ranges of

0.1 pF/uH/m ohm (ie. 0.0001 ohm) to 20,000uF/200H/20 M ohm.

## Vasavi Electronics

(Marketing division)

630, Alkarim Trade Centre, Ranigunj  
SECUNDERABAD-500 003.

ph: 70995

gms: VELSCOPE

## COLOUR TV MANUFACTURERS FOR YOUR REQUIREMENT OF:

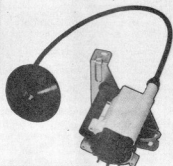

## FLYBACK TRANSFORMERS

CONTACT:



### DANNIES ELECTRONICS ENTERPRISE

Importers and Exporters

77, High Street # 10-12, High Street Plaza,  
Singapore 0617.

Phone: 3372297, 3397696 Telex: RS 28612 ESQUIRE



POOR SOUND?

JITTERY PICTURE?

DROPPED BITS?

# SOPHISTICATED ELECTRONIC CIRCUITS AND SYSTEMS DEMAND PERFECT MAINTENANCE!

## — ONLY **kli-nit**® TF-787 CAN ENSURE IT

Special  
Package  
available for  
**AUDIO/VIDEO**  
TAPE HEAD  
CLEANING

Perfect maintenance means cleaning even the microscopic spots of grit, dirt, flux and oxide build-up that may affect the smooth functioning of the equipments.

KLI-NIT® Electronic grade aerosol cleaner TF-787 does it perfectly, precisely. It dissolves all types of organic flux and safely removes grit, dirt and oxides from any spot and restores ohmic contact.

Specially formulated for high technology applications TF-787 is non-inflammable, non-conductive and safe for computers, telecommunications apparatus, magnetic tape heads, electronic tuners and switches and low energy sensitive contacts.

KLI-NIT® TF-787— a trusted companion for electronic professionals



**Hakotronics** PRIVATE  
LIMITED,

Sussex Road, Bombay-400 027.  
Phone: 872-2888 Gram: "HAKOTRONIX"

## FIRE RETARDANT PRINTED CIRCUIT BOARDS

For  
**Colour & B/W T.V.s.**  
As Recommended by  
Department of Electronics

Imported Material  
NEMA- FR-2/FR-3/FR-4

**GRAFICA**-The name you can rely  
on for quality PCB's.



**GRAFICA  
DISPLAY CO.,**

86, Mathuradas Vasani Road,  
Near Darpan Cinema, Andheri (East),  
Bombay 400 093.  
Phone: 6044464-6321383.

SOSGDD/184

# SOLEX



- Works effectively on single/double sided PC Boards.
- Powerful vacuum suction.
- Low recoil action.
- Dependable performance.
- Assured results.
- Every stroke self cleaning.
- Replaceable tip.

**LARGEST  
SELLING**

## DESOLDERING PUMP

Internationally  
Accepted

With  
**Unmatched  
Performance**

**INDUSTRIAL RADIO HOUSE**  
12, Gandhi Bhavan, First Floor, Chunan Lane,  
Off. Dr. Bhadkamkar Marg, Mumbai - 400 007

Phone : 38 21 04

**LOW COST  
HIGH QUALITY**  
*Relays-a-Plenty*

Series 112, 113, 117  
20 Amps, 25 Amps  
15 Amps.

Series 126  
10 Amps.

Series 106, 111  
25 Amps &  
30 Amps.

Series 134 to 136  
15 Amps, 20 Amps  
& 30 Amps.

Series 105  
5 Amps.

Series 108, 110  
20 Amps, 5  
30 Amps.

Open top  
Series 116 to 124  
0.5 Amps to 5 Amps.

Series 107  
25 Amps.

Series 103  
5 Amps.

Pack of two  
Series 102  
5 Amps.

Small of large quantity orders  
receive the same careful attention  
as the single that have the  
"Know How".

Series 127  
25 Amps.

Series 118 to 123  
0.5 Amps to 5 Amps.

Series 104  
5 Amps.

Series 118 to 123  
0.5 Amps to 5 Amps.

Small of large quantity orders  
receive the same careful attention  
as the single that have the  
"Know How".

Series 127  
25 Amps.

Series 118 to 123  
0.5 Amps to 5 Amps.

**Eagleman**  
*Relay Division*

3/15-A, Kirti Nagar,  
Industrial Area,  
New Delhi-110015.  
Phone: 535770.  
Grams EAGLENT

Series 128  
5 Amps.

Series 106  
5 Amps.

Series 128  
5 Amps.

Series 128 to 134  
10 Amps & 20 Amps.

## WE OFFER FROM STOCK

**I.C.'s :** TTL, CMOS, MOS, LSI,  
Microprocessor, Micro computer etc.

**Zener Diodes :** 400 MW & 1 Watt

**LED's :** Red, Green, Yellow in  
5mm and 3mm dia

**IC Sockets :** SMK & Memorex make

**Trimpots :**

Multiturn Bourn's, VRN & Beckman make

**Single Turn cermet's :**

EC as well as imported

**Floppy Discs :**

8" as well as mini floppy of memorex,  
& dyson make

Write to :



**ZODIAC  
ELECTRONICS  
CORPORATION**

Pushpdant Niwas 3rd Floor, 3, Chunan Lane, Dr. D. Bhadkamkar  
Marg, Bombay-400 007, Phone : 5137225, 5135845

# "OPEN SESAME"

commanded Ali Baba, and lo behold the massive door flung open leading him to his riches.  
This is part of a fairy tale.



Interstate U.S.A., through exhaustive research and development, have mastered the art of voice command and made a fairy tale a reality. You can now enjoy increased efficiency, reduced handmade errors, thereby enhancing productivity and quality by voice commanding your Computers, Machines, Processors, Controllers, Instruments, Typewriters, even Cars — in fact any thing that needs man machine interaction.

Why not try a "Alibaba," beginning with some of the voice recognition chips and systems available, like 16 and 100 word command recognition chips, Total voice recognition systems and Speech recognizers compatible with DEC-VT, C, ITOH and Plessey PT-100 terminals.

E.E.E. can offer you more details on interstate products and those manufactured by other principals overseas, such as:

Tandberg Data, Norway for CRT terminals and Streaming (QIC) cartridge tape drives

Thandar Electronics, UK for Logic Analyzers with personality modules

Trio-Kenwood, Japan for Audio-Video & Entertainment electronic Test and Measuring equipment

Comark Ltd., UK for Thermocouples of all types and grades

You say 'Open Sesame' and we'll help you reach your riches. For further details write to:



## The Eastern Electric & Engineering Company Private Limited

Gyan Ghar, Plot No. 434A,  
14th Road, Khar,  
Bombay 400 052.



# electronics the easiest way

It is well known that children can generate some of the most original ideas on any subject. We can only envy the straightforward simplicity of their answers to questions of a technical nature, especially when the subject is electronics . . .



Some of the most delightful observations about electronic communications have been boldly put to paper by primary school miniprofessors. Take these historical explanations for example.

Question: 'When was the radio invented?' Answer: 'On page 24.'

'The radio was invented in the pre-me times.'

'The Romans did not have radios. They used smoke signals in both the A.C. and D.C. times.'

Children have a knack for discarding everything but what they consider to be the most essential information. One boy brusquely wrapped up all of man's yearnings, struggles and triumphs in this eight word package: 'Progress was from electricity to radios to now.'

Here's a remark as charming as childhood itself: 'I was thinking the radio

was invented before the telegraph. When I learned different, all the thoughts I was going to say went in a swallow down my throat.'

Another tiny historian concluded: 'The Dark Ages lasted until the invention of electricity.'

Through the years, the youngest generations' fund of knowledge has proved to be a glittering gold mine of wit and unconscious wisdom, often conveniently unhampered by hard facts. Each new subject seems to be a fertile new field for off-centred interpretation and lopsided logic. Digging into facts about Marconi produced such notable nuggets as these:

'Marconi was born in 1874, supposedly on his birthday.'

'It took much hard work for Marconi to think out how to invent the radio. He had to keep thinking around the clock, twelve days a week.'

'In just a few short years he became a sensation overnight.'

'He expired in 1937 and later died from this.'

Recently a bright-eyed little radio enthusiast came up with this endorsement: 'Every time I think how the radio gives us so much fun, I have joy feels all over.'

A skeptical classmate of hers absorbed all the statistics regarding the number of ham radio operators, but got his skepticism across in one crushing statement: 'The total amount of ham operators today is more for saying than believing.'

It must run in the family. Two years later his younger sister reported: 'The

number of ham operators we have today is an absurdly large fact of a number.'

The subject of hams has stupped many eager young scholars. Here are three more futile but imaginative explanations:

'Ham operators look something like people.'

'They are one of the chief by-products of electricity.'

'The meaning of them has a very short memory in my mind.'

The elementary school youngster's mind seems to be a vast storehouse of miscellaneous misinformation - half true, half false and wholly delightful. His fund of knowledge about electricity includes such fascinating items as these:

'Electricity has been with us forever and maybe even longer.'

'Would the average person be able to keep up with the news if it was not for electricity? The chances are 999 out of a hundred.'

'In electricity, opposites attract and vice versa.'

'If you see lightning, no you don't. You see electricity.'

'From now on, I will put both gladness and wonder in my same thought about electricity.'

Here's one I've been trying to figure out for five years: 'You should always capitalize the word electricity unless it is not the first word in the sentence.'

This next little girl seemed to be giving it all she had when she wrote: 'Correct my being wrong, but tell me true or false. Do negative charges go through electrons or through protons? I wrecked my brain trying to think which.'

But I'm afraid others are more nonchalant in their pursuit of knowledge: 'Protons are bigger than electrons in case I ever want to know.'

Psychologists tell us that half learning a fact incorrectly is often the first step to learning it right. So let's be philosophical as we buzz through these fractured facts about electrons and protons:

'100 electrons equal 1 radio program.'

'When the switch is on, electrons are constantly bumping into each other outside the wire. There is really quite an overpopulation of electrons.'

'Once I saw in an educational cartoon about how electrons move. Electrons are very interesting folks. All their ways are hurry ways.'

'Electrons carry the negative charge while protons take the affirmative.'

'Electrons are the same as protons only just the opposite.'

'I think I admire the electron more than anything else about electricity because it weighs only about one over 2000th as much as a proton but can still hold its own.'

When questioned, children offer the ever present possibility that however far from right their answers may be, the next wrong answer could be more witty and thought-provoking than the correct one. Sometimes they don't know and

they know they don't know, but that doesn't keep their answers from being charming:

'Ideas about how radios work have advanced to the point where they are no longer understandable.'

'Did I pass the test about how to get a ham radio operator's license and why not?'

'I have found radios to be easier to listen to than to tell how they work.'

Take three small boys, mix them up thoroughly with several pounds of strange facts, then shake up with an examination and you have the perfect formula for instant confusion.

'The way vacuum tubes work, as I understand it, is not very well understood.'

'Many questions have been aroused in my mind about vacuum tubes. As a matter of fact, the main trouble with vacuum tubes is that they give more questions than answers.'

'In electricity, positives are attracted by negatives for the reason of search me.'

Often a grownup can only envy the simplicity of a child's way of expression, as is the case of the lass who remarked: 'When I learned we were going to see a movie about ham operators all over the world, I told my feet to quiet down but they felt too Saturday to listen.'

In their world of uncertainty, once they know a fact for certain, they hang on to it tenaciously, e.g.: 'Another name for the radio is radiotelephony, but I think I will just stick with the first name and learn it good.'

Children, like mountain climbers, must always make sure that their grasp on a fact is firm, even though they want to leap far beyond. Otherwise, they may find themselves trapped on a mental ledge. There is usually at least an element of truth in the most absurd answer. Sometimes they aren't wrong at all. It's just the way they put it that's so funny:

'Radio has a plural known as mass communication.'

'Water scientists have figured out how to change river currents into electric currents.'

'The best thing live wires are good for is running away from.'

'Quite a bit of the world's supply of electricity goes into the making of ham radios.'

'Many things about electronic communication that were once thought to be science fiction now actually are.'

Members of the primary school set certainly have their own opinions, and few are hesitant to express them:

'All the stuff inside a ham radio is so twisted and complicated it is really not good for anything but being the stuff inside a ham radio.'

'Electronics is the study of how to get electricity without lightning.'

How about this unforgettable remark: 'Last month I found out how a radio works by taking it apart. I both found

out and got in trouble.'

And you can't argue with the young fellow who reported: 'When currents at 200 to 240 volts go through them radios start making sounds. So would anybody.'

Just what is a vacuum? Here are five answers, fresh from the minds of nine-year-olds:

'Vacuums are made up mostly of nothings.'

'A vacuum is an empty place with nothing in it.'

'Vacuums are not anything. We only mention them to let them know we know they're there.'

'There is no air in vacuums. That means there is nothing. Try to think of it. It is easier to think of anything than nothing.'

'A vacuum tube contains nothing. All of its parts are outside of itself.'

Another lad wrote of this frustrating experience: 'I figured out how a vacuum tube works twice but I forgot it three times.'

One of his classmates reported: 'When I learned how empty vacuum tubes are, I would have fainted if I knew how.'

If you're at all hazy about other parts in a radio, hang on. These next thoughts will leave you only slightly worse off than before:

'An electron tube can be heated two different ways. Either Fahrenheit or Centipede.'

'When you turn a radio on, the tubes get hot. The hotter anything gets, the faster the molecules in it move. Like if a person sits on something hot, his molecules tell him to get up quick.'

'In finding out that radio tubes get hot, the fun is not in the fingers.'

'Transistors are what cause many radios to play. Transistors are a small but important occupation.'

'We now have radios that can run on either standard or daylight time.'

One student had many tussles with his spelling book. When he finished writing one particular sentence, the battleground looked like this: 'termanuls do not agree with themselves spelingly and pruncingly.'

With apologies to Mr. Webster, I would like to present a pocket-size dictionary of pint-size definitions, compiled from school children's reports. Should any of them prompt Webster to turn over in his grave, he would have to do so with a smile:

'Actually, a *choke coil* is not as dangerous as its name sounds.'

'*Electromagnets* are what you get from mixing electricity and magnets together.'

'Think of a *volt*. Then yippee, because now you have had the same thought as Voltaire, after who this thought was named.'

Another lad had the right information, but the wrong answer: 'There are some things about electricity we are still not sure of. These things are called *whats*.'

If the kids don't know all the answers, they can always do what their parents

once did — try to slide by on a guess or two:

'A *radio telescope* is a thing you can hear programs by looking through it.'

'*Current electricity* is electricity that is currently in use.'

Children are so full of questions, they can't possibly wait for someone to tell them all the answers. That's why they plunge recklessly ahead on their own, like so:

'Sound travels better in water than in air because in water the molecules are much closer apart.'

'I have noticed that if a portable radio is turned in different directions, the station talks loudest behind its back.'

'Although air is hollow it is not just for looking through. It is also for having radio waves running through it and trying to answer questions about.'

'Radio waves would not be all that important to study if it were not for ears.'

'Someone in here said that FM has shorter waves than shortwave radios. Is this so? I think it is because I think I was the one that said it. (If you can't believe yourself these days, who can you believe?)'

An obviously more confident young man proclaimed: 'Much has been said about how radio waves travel. Radio waves are both hearable and talkable.'

The last word must go to this moppet who was doing well — until the last word:

'I believe the radio is one of the most important inventions of all time. Of course my father works at a radio station, so I may be a little pregnant.'

That's one young writer who would have done fine if she had just stopped while she was ahead (which is good advice for grownup writers, too).

By kind permission of 73's magazine. 

## COMING SOON!

elektor will soon unfold the mysteries, that surround electronics, to these inquisitive minds.

Our new section SELEX (Simple Electronics Experiments) is aimed at students and beginners. SELEX will teach "electronics the easiest way"

Turn over for more information on



## Learn electronics the easiest way!

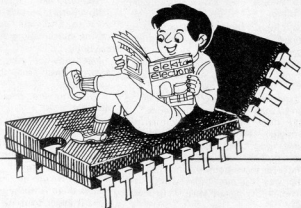

### **What is SELEX?**

SELEX is a new section to be introduced shortly in *elektor india*, as a regular feature. SELEX stands for Simple Electronic Experiments. SELEX will teach various topics in electronics in a very simple and elementary manner! Even a layman can learn basics and a lot more in electronics through SELEX. SELEX will be the most 'Reader Friendly' section. Students and beginners who always had a feeling of being deprived, can now shake off that feeling and get ready to catch up with today's incredibly rapid advances in electronics.

### **SELEX will tell you!**

You have always wondered about how things work? Now, SELEX will tell you! From simple test instruments to complex Radar systems, SELEX will tell you how they work. It will be a journey right into these equipments.

SELEX will tell you all about raw materials and construction of various components, tools etc. like soldering irons, transformers, battery cells, active and passive components and many more things.

If you have avoided experimenting with electronics for the fear of blowing up costly components or equipments, now SELEX will tell you how to use components, tools and instruments with care and avoid misuse and damage.

A student, a beginner, a hobbyist can always reach the professional level with 'Hands-on' experience through SELEX. SELEX will bring you interestingly devised experiments to teach you the basic principles of electronics.

Getting all the data about the components you are using is as important to the process of learning as the experiment itself. SELEX will provide all component data that you would need to have.

If you are fascinated by bits and bytes, TTL, CMOS, ECL, NMOS, now SELEX will tell you all about it! A specially devised step by step 'Digital Course' will soon be introduced in SELEX.



Watch out for  
**SELEX**  
in the coming issues  
of *elektor india*.

If you are a student, beginner or hobbyist  
you can not afford to miss SELEX.  
The best way to avoid disappointment is to  
become a regular subscriber to *elektor india*.

the government, whose ostensible aim was to make available the components in plenty at internationally competitive prices. Mr. Venkatraman opined that there was no definite policy on components at all.

The prices of some Indian components were even now comparable to international prices but in the case of some other indigenous components, there was no possibility of achieving any price parity in the foreseeable future, he added.

The danger, according to Mr. Venkatraman, lay in the import-based growth as in the absence of real domestic base of components the industry would collapse.

#### Bush Computers

Bush India Limited has tied up an agreement with a leading US electronics company, General Automation, for the manufacture of micro computers.

General Automation's director of sales for South East Asia,

Mr. Carlton J. Parker is quoted as



saying that the collaboration envisaged introduction of PICK computer operating systems for the first time in India, which is said to be more flexible and interactive than the other prevailing systems. Five models of the Zebra series and two others of the Unix operating systems are to be made available to India and the retail price of each system is expected to be around Rs. 3.50 lakhs.

Mr. Ashok Aggarwal, marketing manager of Bush, has stated that the machines would be targeted mainly to the medium and large scale public and private sector units which require many terminals to be connected to one main computer for information sharing. The company would initially make about 100 Zebra systems per annum. The company will also manufacture home computers called PH-1, IBM-compatible personal computers called the Bush Attache and the PICK-based, IBM-compatible, personal computer called Bush PC.

## selector

### 2000 kilowatts under the sea

In 1927, The Netherlands became one of the first countries to recognise the power of the short-wave broadcasting medium. Early experiments via station PCJ in Eindhoven were convincing enough to make a solid investment in the future. But the shortwave dial has certainly changed these last 58 years and, to maintain and improve the flow of information from broadcaster to listener, technology has had to adapt too. These days, it's quite common to read in broadcasting or shortwave-listener magazines that a new transmitter is going on the air. Radio Nederland Wereldomroep's solution, though, has some rather unusual aspects to it.

Two million amongst fourteen million You can't put a shortwave transmitter site anywhere! Not only are the aerial masts up to 120 metres high, but they need to radiate concentrated beams of energy into the air. Finding a nice secluded spot in The Netherlands, a small country with 14 million people, is a difficult task. In 1937, the Dutch made broadcasting history when they constructed a wooden rotatable, directional shortwave aerial. It was at a place called Huizen (pronounced How-zen), a few miles north-east

from the studios in Hilversum. This huge construction would swing round to point the aerial in different directions. Today, an inscription in an apartment block, the 'PHOHl flats' marks the spot where the aerial once stood.

In the 1950's, shortwave broadcasting from The Netherlands moved to the centre of the country, to the village of Lopik in the province of Utrecht. There was room for future expansion in those days, but not now. As the Lopik facilities began to show their age, the search started for a new place to put the shortwave transmitters. In fact, the solution was to start construction within a few miles, as the crow flies, of the old Huizen aerial site. Four 500 kilowatt transmitters were ordered, plus one 100 kW reserve transmitter. But not only is the transmitting centre new, so is the land it's built on.

The 28th of May 1932 saw the birth of a new lake in The Netherlands, with a size of 1200 square kilometres. Completion of the so-called 'Afsluitdijk', a dike some 30 kilometres long, meant part of the former Zuiderzee was no longer open to the wild North Sea. It was given the name 'IJsselmeer'. Plans didn't stop there, for then began an ambitious draining scheme to create new areas of land previously covered by the sea. The

largest of these, Flevoland, was pumped dry in two stages between 1950 and 1968. Today it's already an established area for arable crops, and now also for shortwave broadcasting. Radio Nederland Wereldomroep's new 'Flevo' transmitting centre is also an ambitious project in its own right. To be efficient, a shortwave transmitter needs efficient directional aerial, which means that for the lower shortwave broadcasting bands, such as 49 metres, this entails very large constructions. Since Flevo is four metres below sea level, the water table is quite high and the ground is also rather soft. New techniques have had to be found to anchor the aerial masts securely, since the totally flat polder means everything is exposed to the full force of windy weather.

#### Up in the air

Flevo is equipped with some so-called 'omni-directional' aerials used to serve nearby target areas in Europe. These radiate energy in all directions. But the days of being able to serve listeners all over the world with one frequency are over. Now, 'directional' aerials are far more important, especially to serve distant target areas. So these aerials concentrate the energy into a relatively narrow beam. This not only gives a stronger signal in the chosen target



area, but it means that interference to other stations, serving different parts of the world on the same frequency, is reduced to a minimum. This in turn contributes to less overcrowding of the shortwave spectrum. Aerial design is a specialized part of engineering technology. A directional aerial is more than a simple dipole strung between two supporting towers. In fact, most of the Flevo aeriels consist of sixteen dipoles, arranged in four rows, each of four dipoles, forming a so-called 'curtain array'. A screen of horizontally strung metal wires is put behind the stack of dipoles, acting rather like a mirror. This ensures that energy is radiated in one direction only. The size of the dipoles is important, as some aeriels are designed only to operate on four out of the total of nine shortwave bands used by Flevo for international broadcasting. If you try to operate an aerial on frequencies outside the ones it's designed for, it will not match electrically. Energy is then reflected back into the transmitter, and generally lost as excess heat. Since Flevo uses about 3.5 million watts from the mains electricity (think of it as paying the electricity bill for 35 000 light bulbs), it's important that as much of this energy as possible is used for broadcasting programmes.

Whilst computer programmes exist to calculate how a chosen aerial design SHOULD perform in theory, a lot of natural or man-made factors (like the type of soil, nearby metal aerial towers, etc.) also have to be considered in practice. So, having hung the aeriels between the supporting towers, the Dutch PTT hired a helicopter equipped with special measuring apparatus, and switched the transmitter on with reduced power (20 kW). By flying in a circle with a radius of 2 kilometres from the aeriels, it was then possible to plot the radiation patterns of each aerial. At a height of 500 metres, the beam direction is measured to within 2 degrees, together with the beam width and elevation.

The exact direction an aerial will beam to depends mainly on its physical orientation on the ground. The 'star' shape of the Flevo aerial complex means that all directions of the compass between 050 and 290 degrees can be reached. It's also possible to electrically change the beam direction of some aeriels. If an aerial normally beams due east (equivalent to 090 degrees) it can be adjusted to operate at 060, 075, 105 and 120 degrees as well. Changing the direction more than this would lead to undesirable energy loss in

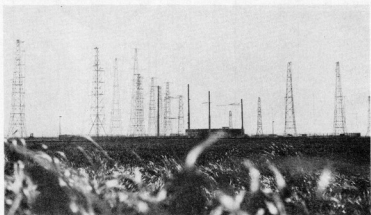

unwanted directions. No aerial can be one hundred per cent efficient. As well as beaming energy in the desired direction, some signal will also go in the opposite direction. This is termed 'back-radiation'. If, for example, 500 kilowatts is beamed one way, as much as 50 kilowatts is often sent the other way. By design and careful measurements at Flevo, this back radiation has been reduced to a minimum. The ratio of radiated energy at the front of the antenna, against the power measured at the back, is now as high as 20 dB. This means that only around 5 kilowatts are radiated into the opposite unwanted direction.

All these factors are important in ensuring that the energy isn't wasted. Flevo is believed to be the first shortwave station where such intense aerial diagram measurements have been done from the air, before the transmitter site enters service. With such high powers being used, the feeder lines to the aerial have had to be covered. At previous transmitting sites these were simply bare wires on poles, but since they offer a potentially lethal hazard to birds, extra precautions were taken with the new project. These feeders are now constructed of coaxial cable, which means that high voltage areas are screened.

**On the ground**  
The transmitter design also contains some new concepts. Since short-wave broadcasting began, a system known as Amplitude Modulation, AM, has been used to get the signal from transmitter to receiver. The AM signal involves two components:

1. The 'carrier' which puts the signal on a certain part of the shortwave dial, and is needed by the shortwave receiver as a sort of 'reference point'.
2. The modulation, which is actually

the speech and music information the broadcaster wants to put across. The problem is that more than fifty per cent of transmitter energy is put into the carrier part of the signal, which in fact contains no programme information at all. Ways around this are planned for the future, with more efficient forms of transmitting techniques, but most require that the listener buys a new type of radio. This isn't practical yet. But modern transmitter design enables the use of a more efficient form of AM, known as Dynamic Amplitude Modulation (DAM). With normal AM in widespread use today, the level of the carrier remains at a constant level. In the DAM technique, the carrier power moves in step with the modulation. So, during a loud piece of music the carrier power is turned up, but when the music gets softer, the carrier power is turned down. This is done electronically, and can mean anything up to a twenty-five per cent energy saving or more! This is achieved without a noticeable quality reduction of the signal at the listener's end. The use of DAM can be noted on the signal strength meter of a shortwave radio, the needle moving in step with the programme being listened to.

This DAM technique, together with other energy saving designs incorporated into the transmitters, means that while the total power output of Flevo is 5 times that of Lopik, the power bill is expected to rise by only about 2.5 times for the same hours of usage. The transmitters are cooled both by water and air systems. Three hundred litres of water per minute passes through each sender, and the excess hot air is used to heat the building.

Computer technology is also used to the maximum. Changing frequencies at the old Lopik transmitter facilities was quite an ordeal. Moving from

one band to another often entailed physically moving and tuning quite a number of parts of the transmitter. It's a credit to the transmitter crews that they managed to do this with the required precision in the short time available between programmes. Modern multi-band transmitters have eliminated the need for this type of manual labour. But engineering skill is now focussed instead on maintaining a highly complex computer controlled switching system. New programme and frequency schedules are entered into a computer terminal at Radio Nederland Wereldomroep, where it's possible to monitor what's happening some 16 kilometres away.

#### The start of a new era

The testing phase of the transmitter complex is now nearing completion. A new programme and frequency schedule will commence on 31 March 1985 taking advantage of the ability to serve new areas of the world with a stronger signal.

The philosophy of Radio Nederland remains unaltered. As a non-commercial public foundation, financed from the Dutch radio-tv license fee, its aim is to bridge the information gap between this part of Europe and the rest of the world. This is done by not only examining one's own point of view, but also those in the listener's region. Only then can one speak of 'communication'.

#### From dream to reality!

If you want to tune in the world, you really only need three things: a pair of ears, a shortwave radio, and an aerial. Getting a good shortwave receiver is less of a problem these days, but most shortwave listeners and radio amateurs wish they had more space to put up a better aerial. After all, you can own the world's best receiver, but without a suitable aerial, all you'll hear is interference and a few of the stronger signals. Radio Nederland Wereldomroep (or Radio Netherlands as it is called in English) is a shortwave broadcasting station, based in Hilversum, The Netherlands. It has built up a unique consumer information database on shortwave receiving equipment, publications, and accessories, with the aim of assisting shortwave listeners around the world. As the preceding section explains, the station will shortly have a new transmitting centre located on the Flevo-polder. But, before it enters service on 31 March 1985, the Flevo site will be the location of a unique amateur radio experiment.

On the third weekend in February, two ordinary amateur radio transmitters will be taken out to the new transmitter site. The transmitters will be set up as usual, following the requirements laid down by the Dutch PTT licensing authorities. The difference is that these transmitters will be connected to some of the largest directional shortwave aerials in the world! The plan is to use the new Flevo transmitting site aerials ON AMATEUR RADIO FREQUENCIES for a period of 36 hours. Not only will this be a unique chance for the operators to work with such high-gain aerials and examine the results, but it offers a rare opportunity for radio amateurs and shortwave listeners to listen out for a station with a difference! This is about as close as possible to the shortwave enthusiasts dream station equipment. The amateur radio station will be on the air between 0600 GMT on Saturday 16 February 1985 and 1800 GMT on Sunday 17 February 1985. This is a continuous period of 36 hours of operation. One transmitter will operate on a non-directional aerial, intended for European reception. The second will make full use of the giant curtain arrays at the Flevo shortwave transmitter site. The direction of the beam will follow the pattern of the regular English language broadcasts from Radio Netherlands, i.e. at 0730 GMT, when Radio Netherlands is on the air to Australia and New Zealand, the amateur radio station will beam in that direction too, though on a different part of the shortwave dial.

The special event amateur radio station will operate in single side-band (SSB) and CW (Morse) modes. The Dutch PTT has allocated the special call-sign 'PA6FLD' for this occasion. A special QSL card, depicting the new Flevo transmitter site, and the amateur radio operation, will

be sent to all those submitting correct reception reports. Licensed radio amateurs will, of course, be able to talk directly to the operators at the station. But shortwave listeners are encouraged to look for the station too. Exact frequencies for the amateur radio stations will be announced nearer the date, during the "Media Network" programme. Details of this are listed below.

#### Special Radio Netherlands English language programmes too!

Between 0730 GMT on Saturday 16 February 1985 and 0630 GMT on Sunday 17 February 1985, Radio Netherlands' regular English language programmes will pay special attention to this amateur radio event. Several transmissions will originate live from the amateur radio shack at Flevo to watch the progress. Attention will also be given to the development of the Flevo transmitter site and the polder in which it is built. Interviews with members of the Dutch amateur radio community and the PTT are also envisaged. This special programme can be heard at the times and frequencies given below.

Further details of this event will be announced in the regular weekly shortwave communications magazine programme "Media Network". This is heard each Thursday on Radio Netherlands' English Service, at the same times and frequencies listed below.

For any further information please contact:

Jonathan Marks  
English Section,  
Radio Nederland Wereldomroep  
P.O. Box 222,  
1200 JG Hilversum  
The Netherlands  
Tel: (31) 35 16151 (ext 344) (Mon-Fri  
0800-1600 GMT). (959 S)

#### Saturday 16 February 1985

Time (GMT)	Frequency (kHz)	Beamed to
0730	9770, 9715	Australasia
0930	15560, 11930, 9895, 6045, 5955	Europe
1030	9650, 6020	Australasia + Caribbean
1300	17605, 11935, 9895, 6020, 5955	Europe
1430	21480, 17605, 11735	South-East Asia
1830	9540, 6020	East/Southern Africa + Europe
2030	17605, 15560, 11740, 11730, 9540	West Africa (also audible in Europe)

#### Sunday 17 February 1985 (still Saturday night in the listener's area).

0230	9590, 6165	East Coast North America
0530	9715, 6165	West Coast North America

from an idea  
by F. Lemoine

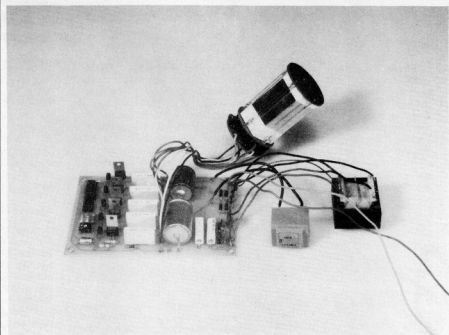

# gyroflash

Every once in a while some Elektor reader sends us a circuit that does not fall into any of our standard categories but is none the less interesting. This gyroflash is just such a design. It consists of five xenon tubes that flash one after another so that the light moves around in a circle as in a lighthouse. Call it what you will — party trick, novelty or simply 'flashing thingummyjig' — the gyroflash is an interesting design idea. The fact that it can also be of practical use simply makes it all the more interesting.

five sequential  
rotary flash  
tubes controlled  
by a single  
circuit

Practical projects have always occupied most of the space in any issue of Elektor. Every now and again, however, an interesting design appears and is found to be not very practical from the point of view of how useful it is. Gyroflash is an interesting design that also has a practical value. It could be considered as a slave flash and with a very long exposure time this could probably provide some very interesting results. Avid scale modellers could use it as the base for a sophisticated miniature lighthouse. Others may like to use it as a simple novelty or build a party trick around it. It could also be used as a traffic warning or distress light as it does not need a mains power supply. What appealed to us, however, is not the use but the circuit itself, which is interesting purely as a design idea.

## The circuit

The most obvious characteristic of the circuit, which is shown in figure 1, is the

repetition: the same circuitry is used five times to drive the five flash tubes. A pair of transistors, T1 and T2, and transformer Tr6 form an oscillator generating a frequency of about 50 to 60 Hz. The transistors are protected by diodes D1 and D2 ( $-U_{BE}$ ) as well as D3 and D4 ( $U_{CEmax}$ ). The voltage at the secondary winding of Tr6 is rectified by D5...D8 and C1 to about 250 to 300 V d.c. Variations in load are smoothed by capacitor C1. The actual charge that ignites the xenon flash tubes is stored by electrolytic C2. A resistor, R1, is included between these two electrolytics to prevent C1 from being affected by the discharging of C2. If a higher output is needed for the xenon tubes R1 can be replaced by a suitable coil, such as the primary winding (a.c. side) of a 10 VA transformer. If the circuit is only used for short periods of time the resistor is the better choice. The inductor should be used if the gyroflash must operate continuously for a long time.

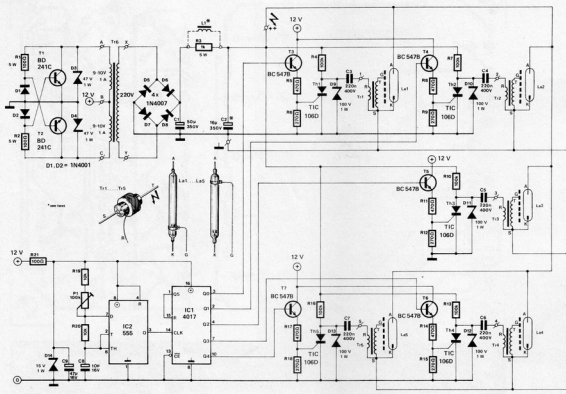

## The driver stages

The five driver stages are, as we have already said, identical so we will simply consider one as an example. In the quiescent state capacitor C3 charges up to about 100 V via R4 and one of the windings of Tr1. When a logic '1' (+12 V) is applied to the base of T3 this transistor conducts and triggers thyristor Th1. The 220 nF capacitor, C3, then discharges through Th1 and Tr1. The high voltage that appears across the secondary winding of the transformer triggers La1. The xenon gas inside the tube is ionised and is therefore conductive, with the result that capacitor C2 discharges through La1 and causes it to flash.

## A pulse generator

We have just seen how the driver stages cause the xenon tubes to flash but have skimmed over one important point, namely how the stages are themselves triggered. A second oscillator, based on IC2, is used for this. Its frequency can be preset with P1 to between 1 and 4 Hz. The output of the oscillator (pin 3) clocks IC1 and this 4017 enables each of outputs Q0...Q4 in turn. When Q5 is enabled IC1 is immediately reset. As each of the outputs goes high it triggers the transistor in the driver stage and the tube (one of La1...La5) flashes. In this way the xenon

tubes flash in turn at a speed determined by the setting of preset P1. The two ICs in this pulse generator stage are protected against excessively high voltages and noise by R21, C9 and D14. The gyroflash requires an external power supply providing a stabilised +12 V d.c. A 12 V car battery is ideal but mains operation is also possible. In this case Tr6 and all components to the left of it are replaced by a suitable isolation transformer (winding ratio 1:1, 220 V/50 VA) connected straight to the mains. Current consumption depends on the frequency at which the circuit operates. If IC2 is oscillating at 1 Hz about 1.2 A is needed but if the frequency is increased to 10 Hz (in which case C8 will have to be reduced to 4.7  $\mu$ F) the current consumption rises to 2.5 A.

## Construction

The gyroflash, as shown in the photograph, is assembled on four printed circuit boards, three of which are very simple. The three circular boards serve to interconnect xenon tubes and trigger transformers and to hold them in place. Wires from the driver stages are connected to the lowest board. The high voltage wire (+) feeds through both lower boards and connects to the anodes of La1...La5 on the upper board. In the

Figure 1. The most obvious part of this circuit is the five identical flash-tube driver stages. The rest of the circuit provides a high voltage for these stages or triggers them at the right time. Note that transistors T1 and T2 do not need to be fitted with heatsinks unless they are cased into a very confined space.

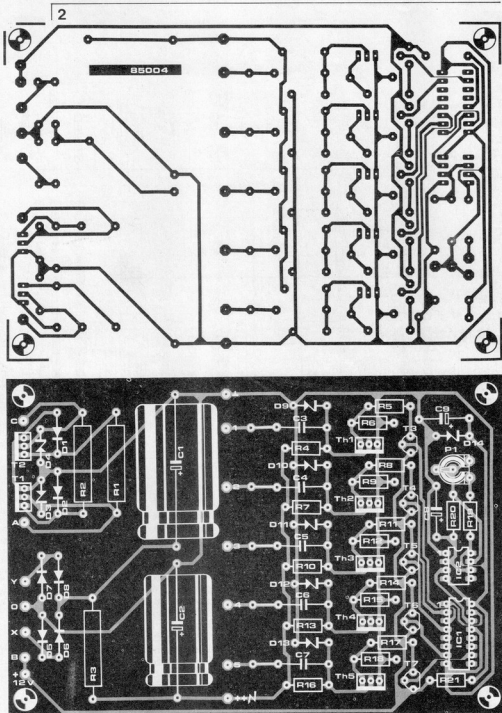

Figure 2. The principal printed circuit board of the gyroflash. Again it is the repetition of the driver stages that stands out. Never work on this board unless you are absolutely sure that capacitors C1 and C2 are completely discharged. This can be done by bridging each of their terminals in turn with a length of insulated cable.

#### Parts list

##### Resistors:

R1, R2 = 100  $\Omega$ /5 W  
 R3 = 1 k/5 W\*  
 R4, R7, R10,  
 R13, R16 = 100 k  
 R5, R8, R11,  
 R14, R17 = 470  $\Omega$   
 R6, R9, R12,  
 R15, R18 = 270  $\Omega$   
 R19, R20 = 10 k  
 R21 = 100  $\Omega$   
 P1 = 100 k preset

##### Capacitors:

C1 = 50  $\mu$ /350 V\*  
 C2 = 16  $\mu$ /350 V\*  
 C3...C7 = 220 n/400 V  
 C8 = 10  $\mu$ /16 V  
 C9 = 47  $\mu$ /16 V

##### Semiconductors:

D1, D2 = 1N4001  
 D3, D4 = 47 V/1 W zener  
 D5...D8 = 1N4007  
 D9...D13 = 100 V/  
 1 W zener  
 D14 = 15 V/1 W zener  
 T1, T2 = BD 241C  
 T3...T7 = BC 547B  
 Th1...Th5 = TIC 106D  
 IC1 = 4017  
 IC2 = 555

##### Miscellaneous:

L1 = \*  
 La1...La5 = xenon flash tubes  
 Tr1...Tr5 = trigger transformers for La1...La5  
 Tr6 = transformer, primary 2  $\times$  9 V/1 A, secondary 240 V  
 \* = see text

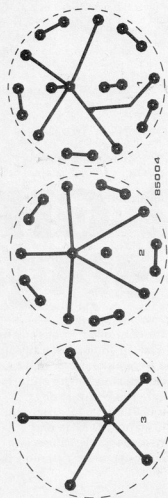

same way the ground line travels via the lower board to the middle one where it is linked to the cathodes of the xenon tubes. Neither of these wires is visible in the photograph as they are fed behind the mirrors we have used to enhance the appearance of the gyroflash. The usual rules of construction apply for this circuit. Work carefully and there should be no problem. Most of the wiring between the various boards carries high voltage and/or high current so make sure the cable used is thick enough to withstand the load. NEVER WORK ON THE CIRCUIT WITHOUT FIRST DISCHARGING CAPACITORS C1 AND C2. Failing to do this can quite literally be lethal. When the circuit is constructed and wired up it must be calibrated. All this involves is setting preset P1 so that the tubes flash at the frequency you find best. If the maximum frequency is not fast enough for your purposes the value of capacitor C8 can be reduced to  $4.7 \mu\text{F}$ . The size of the flashing element is determined by the length of the xenon tubes

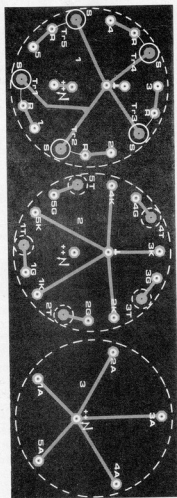

and the size of the trigger transformers. Provided the tubes are matched to the transformers the electrical specifications of both are of little consequence except that the transformer primary voltage must be between about 250 and 300 V. (A suitable combination of transformer and xenon tube is advertised in the optical section of the Maplin catalogue.) We 'decorated' the gyroflash prototype to improve the effect generated. This was quite simply done by fitting a highly-polished piece of thin metal behind each of the flash tubes to reflect its light. The five metal plates were soldered at the rear to hold them together. The gyroflash can, of course, be embellished or cased to suit the purpose to which it is put. Whatever the purpose and whatever type of case is used, one point cannot be too strongly stressed. Use a well-insulated case as this is just the sort of project that attracts prying fingers. These prying fingers might not survive a shock from a wire carrying 240 V (or more)!

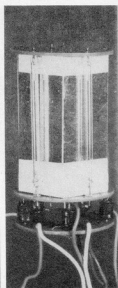
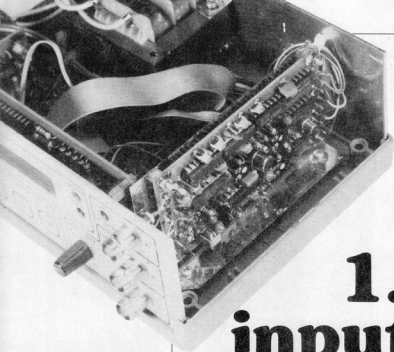

Figure 3. These three circular printed circuit boards hold the xenon tubes and trigger transformers in place and interconnect them electrically. If any layout other than this circular one is desired these boards can, of course, be discarded.



on the main printed circuit board of the frequency counter depending on whether the prescaler is included or not. We will return to this point later but let us start at the beginning, with the 'lowest' part of the input stage.

### The different sections

We will start at the LF stage shown in figure 1. At the input is a dual-gate MOSFET connected as a source follower. A current source (T2) is included in the source line to minimise the attenuation caused by T1. A MOSFET was used

# 1.2 GHz input stage

One important part of the microprocessor-controlled frequency meter described in the February 1985 issue of *Elektor India* is still missing: the input stage. This largely decides the frequency range that can be measured and the sensitivity of the input. Because of its importance a lot of time has been spent on its design. The result is an instrument with a large frequency range (0.01 Hz to 1.2 GHz) and excellent sensitivity of 10 mV<sub>rms</sub> from 10 Hz to 100 MHz and 100 mV<sub>rms</sub> up to 1.2 GHz. These are very respectable values and make the frequency counter suitable for almost every situation that might arise.

super range for  
frequency  
meters

The input stage described here was designed especially for our new frequency meter but it could also be modified to suit other frequency counters. The layout of the input stage must be borne in mind, however, especially the fact that it has three inputs. These are:

- A low frequency (LF) input for analogue signals from 10 Hz to 10 MHz. The sensitivity can be set with a potentiometer.
- A digital input for CMOS and TTL signals up to 10 MHz.
- A high frequency (HF) input consisting of two sections, namely a HF amplifier for frequencies up to 100 MHz and a prescaler that goes from 100 MHz up to 1.2 GHz. The 'normal' HF signal is divided by 16 and the prescaler signal by 512. Each user can tailor the input stage to his own needs. If it is used with the microprocessor-controlled frequency counter we recommend that at least the sections for the three inputs be built as they are present on the front panel and they are catered for in the processor section. If no frequencies above 100 MHz are to be measured the prescaler IC and associated divider can be omitted. One of two wire bridges (PR or  $\overline{\text{PR}}$ ) must be fitted

because of its minimal input capacitance. The advantage of this is that quite a large resistance ( $R1 = 5k\Omega$ ) can be used for input protection without reducing the sensitivity of the circuit at high frequencies. Together with the zener diode integrated in the MOSFET, R1 protects the input against excessive voltages up to about 100 V<sub>pp</sub>. The impedance of the source follower is determined almost entirely by R2 and R3, which means that it is  $4M7/2 = 2M35$ .

The signal travels from the source via capacitor C2 to IC1. This video op-amp is set to an amplification factor of 200x as pins 4 and 11 are connected together. In this configuration the 733 can process frequencies up to about 40 MHz so this is perfectly acceptable for the 10 MHz range. The output signal from IC1 is fed to schmitt triggers N1 and N2 which form a clean TTL signal with steep edges and this is then fed to the frequency counter. The d.c. level at pin 1 of N1 can be set with P2 thereby trimming this section to maximum sensitivity.

• A FET, T3, connected across the inputs of the op-amp and with its base linked to a potentiometer enables IC1's gain to be



changed within certain limits. The potentiometer in question is, of course, P1, the sensitivity control on the frequency counter's front panel. If the gate voltage is set to  $-5\text{ V}$  the FET is turned off and the circuit operates as if it was not there. As the magnitude of the negative gate voltage is reduced T3 conducts more and more with the result that part of the signal from pin 14 of IC1 is also present on pin 1. As with any op-amp, the 733 amplifies the difference between the signals at both inputs so the output at pin 8 decreases the more T3 conducts. In this way the sensitivity can be varied by a factor of 20. Note that T3 must be a BF246A (a BF247A would also work but this has a different pin layout).

The input sensitivity of the stage shown here is at least  $10\text{ mV}_{\text{rms}}$  in the range from  $10\text{ Hz}$  to  $10\text{ MHz}$ . In our prototype the values measured were even better:  $5\text{ mV}_{\text{rms}}$  between  $20\text{ Hz}$  and  $5\text{ MHz}$ . The range actually extended to  $18\text{ MHz}$  at a sensitivity of  $25\text{ mV}_{\text{rms}}$ .

Next we get the digital stage shown in figure 2. In principle the digital signals could also be applied to the A input but the signals' large amplitudes and steep edges could result in an occasional incorrect measurement. For this reason it is necessary to have a special input section for digital signals. The TTL or CMOS signals travel via an emitter follower (T4) to limiter circuit R14/D4/T5. The input to N3 can never be less than  $-0.6\text{ V}$  because of

D4, nor can it rise above  $3.5\text{ V}$  as at this voltage T5 conducts and shorts pin 13 of N3 to ground. The edges of the signal are reshaped by N3 and N4 and it is then fed to the counter. This input is suitable for digital (TTL and CMOS) signals up to  $15\text{ V}$ . There is an interesting point to note about the combination of inputs A and B. The A input is very sensitive and has a high input impedance so this stage will also react to signals applied to input B. This will be seen as a reading on the meter when A is chosen with the menu but the signal is applied to B. This is not an indication of a fault and can cause absolutely no harm. The sensitivity of input A can be reduced to minimum by means of P1 to get rid of the phenomenon but this is not essential.

The third stage is the HF input connected to input C (figure 3). In this case the input signal is fed straight to video op-amp IC3. The input impedance is about  $50\ \Omega$ , as it should be for HF applications. A second op-amp, IC4, immediately follows the first and the combined amplification of the pair is about 50 times. The signal output by IC4 is divided by 16 in flip-flops FF1...FF4 and is then passed to the counter. The sensitivity of this stage is at least  $10\text{ mV}_{\text{rms}}$  in the range of  $10\text{ MHz}$  to  $100\text{ MHz}$  provided IC5 (FF1 and FF2) is a 74AS74 or 74F74. If a 74S74 is used for IC5 the sensitivity deteriorates in the region of  $100\text{ MHz}$ . When we used a 74F74 in our prototype we measured right up to

1

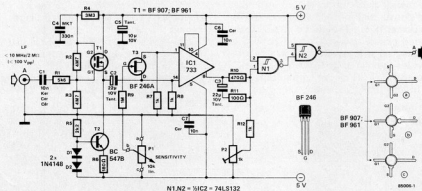

Figure 1. This is the input section for analogue input A. The signal is fed via source follower T1 to an op-amp that amplifies it by 200 times.

2

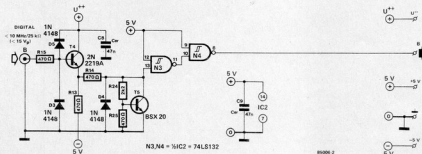
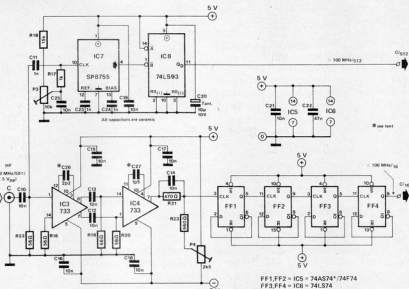

Figure 2. The circuit for the digital input is very straightforward. An emitter follower (T1) precedes a voltage limiter (consisting of R14, D4 and T5). The edges of the signal are then cleaned up again by N3 and N4.

Figure 3. This stage is used for signals above 10 MHz (input C). Signals up to 100 MHz are amplified by IC3 and IC4 and then divided by 16 in FF1..FF4. From 100 MHz up to 1.2 GHz is handled by IC7. The combination of IC7 and IC8 divides these high frequency signals by 512.



140 MHz at a sensitivity of 30 mV<sub>rms</sub>. In order to achieve maximum sensitivity at high frequency capacitors C26 and C27 (shown with an asterisk in the circuit diagram) must be soldered directly to the pins of the ICs on the component side. This is not shown in the photograph of our (old) prototype but is essential because the capacitance is so small in both cases (2p2 and 1p5).

Inputs A and C combined now cover the frequency range up to 100 MHz. To cater for signals between 100 MHz and 1.2 GHz a special IC is needed: the SP8755 high-speed prescaler from Plessey. Input C is connected straight to this IC, which then divides the signal by 64. The 74LS93 (IC8) then divides the signal output from IC7 by 8. In total this gives a division by 512. The

input sensitivity of the prescaler is about 100 mV<sub>rms</sub>. If no signals above 100 MHz are to be measured IC7 and IC8 can be omitted from the board. On the frequency counter's main board PR rather than PR should then be soldered in place.

There are a few important points about the C input that should be borne in mind. This stage is not protected against excessively high voltages as this is virtually impossible at such high frequencies. The maximum input voltage should therefore be 5 V<sub>pp</sub> (about 1.7 V<sub>rms</sub>). On the other hand the signal fed to the prescaler should not be too small. In this case the IC would give a stable output but the division factor might be 32, for example, instead of 64. The bot-

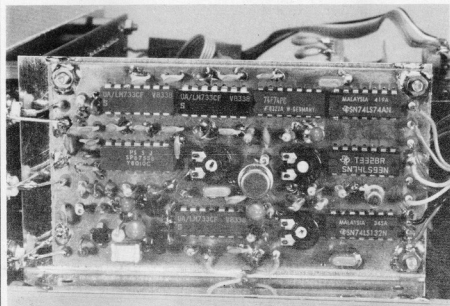

tom line is always to be careful with the amplitude of the input signal when the prescaler is in use.

## Construction

Assembling this fairly small printed circuit board will not be a problem providing the following points are followed.

A large number of the components must be soldered on both sides of the board, wherever there is a copper island, in fact. It is advisable to fit these parts onto the board first:

- C4, C5 (2 x), C6, C7, C8 (2 x), C15, C16, C17, C18, C19 (2 x), C20, C21, C22, C23, C24
- R3, R4, R6, R7, R8, R16, R19, R20, R22, R25
- P2, P3, P4
- D4, T5
- soldering pins at +, -, 5 V, I, and again I (at A, B and C).

All components must be fitted as close to the board as possible and all interconnecting wires must be kept as short as is feasible.

Shorten the soldering pins at inputs A, B

1.2 GHz input stage

4

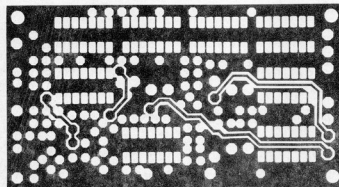
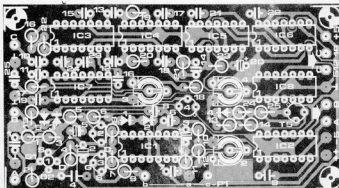
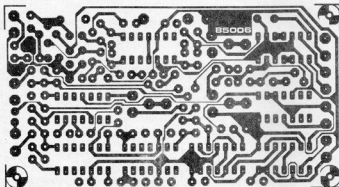

Figure 4. The printed circuit board for the input stage is double sided. The holes are not through-plated, however, so a number of components, as indicated in the text, must be soldered at both sides of the board.

## Parts list

### Resistors:

- (all 1/8 W)
- R1 = 5k6
  - R2, R3 = 4M7
  - R4 = 3M3
  - R5, R24 = 2k2
  - R6 = 180  $\Omega$
  - R7, R8, R12, R17 = 1 k
  - R9 = 1 M
  - R10, R13...R15, R21, R25 = 470  $\Omega$
  - R11 = 100  $\Omega$
  - R16, R19, R20, R22 = 56  $\Omega$
  - R18 = 15 k
  - R23 = 560  $\Omega$
  - P1 = 10 k lin. pot (16 mm diameter, 4 mm spindle)
  - P2 = 1 k preset
  - P3 = 10 k preset
  - P4 = 2k5 preset

### Capacitors:

- C1, C6, C7, C10, C12...C19, C21, C25 = 10 n ceramic
- C2, C3 = 22  $\mu$ /10 V Ta
- C4 = 330 n MKT
- C5, C20 = 10  $\mu$ /10 V Ta
- C8, C9, C22 = 47 n ceramic
- C11, C23, C24 = 1 n ceramic
- C26 = 2p2\*
- C27 = 1p5\*

### Semiconductors:

- D1...D5 = 1N4148
- T1 = BF907, BF961
- T2 = BC547B
- T3 = BF246A
- T4 = 2N2219A
- T5 = BSX20
- IC1, IC3, IC4 = 733
- IC2 = 74LS132
- IC5 = 74AS74, 74F74
- IC6 = 74LS74
- IC7 = SP8755
- IC8 = 74LS93

### Miscellaneous:

- 3 off BNC chassis sockets (screwed fitting)

\* = see text

5

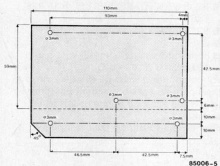

Figure 5. These are the dimensions for the bracket upon which the printed circuit board is mounted. The metal must be bent upward along the dotted line.

bracket by means of small spacers, nuts and bolts. The bolts should be soldered to the ground line on the printed circuit board so that the bracket is well grounded.

The whole assembly can now be fixed to the main board by means of the two self-tapping screws that help keep the main board in place. Make the connections between main and input boards (K3). The three BNC sockets can also be linked to the input board by means of three very short lengths of wire. The sensitivity pot is connected to the board with three lengths of wire. A heatsink is fitted to IC21 (a piece of aluminium of about  $40 \times 40$  mm is sufficient) and the frequency meter can then be switched on to enable the input stage to be adjusted.

6

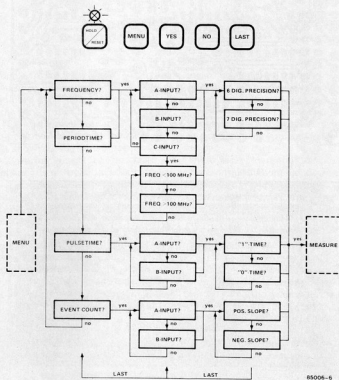

Figure 6. All the frequency counter's functions are given in this menu. A choice is made by pressing the buttons (shown above the menu) on the front panel.

and C to about 2 mm (at the component side). The remaining components can now be mounted. Do not use sockets for the ICs; it is better to solder them directly onto the board. Make sure that C4 is not shorted to ground (at the side that is not connected to ground, we mean).

The printed circuit board can now be mounted in the case for the frequency counter. To do this we must first make a mounting bracket from a piece of thin metal. The dimensions for this are shown in figure 5. The metal should be bent at  $90^\circ$  along the dotted line. The small side of the bracket would stick vertically up if it were laid on top of figure 5. The printed circuit board is now mounted on the

Purely as an aside, the current consumption of the input stage with the SP8755 is about 150 mA at +5 V and 70 mA at -5 V. Without the prescaler it becomes roughly 100 mA at +5 V and 70 mA at -5 V.

### Calibration

Apply a sine wave of about 1 kHz at 50 mV<sub>pp</sub> to input A and set P1 to maximum sensitivity (make sure the pot is properly connected; when it is at maximum the wiper must be at a voltage of -5 V d.c.). Trim preset P2 so that the meter shows the frequency stably on the display. Reduce the amplitude of the input

signal and try to set P2 so that the frequency is still measured stably. Repeat this procedure a few times until the optimal setting of P2 is found. The meter must work properly from at least 30 mVpp. If this is not the case, even at larger input voltage levels, check the connections of T1.

Next we apply a signal of about 20 MHz at 50 mVpp to the C input (after choosing input C, less than 100 MHz from the menu). Assuming that IC7 is used, turn preset P3 completely to the right. Set the HF input to maximum sensitivity with preset P4. Reduce the input signal amplitude progressively until a setting is found that still gives a stable read-out. Use the menu buttons to choose the C input at greater than 100 MHz but apply no signal to the input. Turn P3 slowly towards the left and stop when the trigger LED starts to flash. The SP8755 is now oscillating, which is quite normal for this sort of divider when set to maximum sensitivity in the absence of a signal. Turn P3 slightly back so that the LED no longer flashes. A second piece of metal can now be made (with the same shape as the bracket) to provide a screen for the component side of the board. Solder the two pieces of metal together at the top after covering the inside of the second piece with insulating tape or something similar to prevent short circuits. Some mounting bosses in the top of the case must be removed to enable it to close. Make sure that there are enough holes in the top and bottom of the case to ensure sufficient ventilation but do not make them so large that the 220 V connections are exposed.

## Operating instructions

Perhaps 'operating instructions' is a bit of a misnomer for this section as the frequency counter is quite simple to use. What we had in mind is more of an introduction to the few controls it does have.

The menu of the meter is reproduced in figure 6 as this is the base from which we always work. In the vast majority of cases the user will know what sort of signal is being measured and will therefore know whether to feed it to input A, B or C. When the meter is switched on it selects the 'frequency' position and input A. To choose another function press the menu button. First we get the main choices: frequency, period time, pulse time or pulse count (event counter). Choose one by pressing the 'YES' and 'NO' buttons as appropriate. The next selection to be made concerns the input. If a frequency or period measurement is already chosen inputs A, B and C are all available, but for pulse time and event counter only inputs A or B may be selected. If input C is chosen there is a further choice to decide if the prescaler is needed (above 100 MHz). With frequency or period measurements there follows a choice of 6

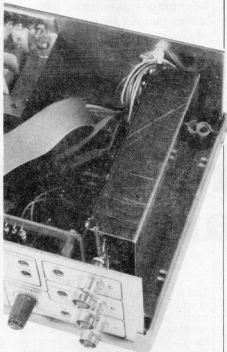

1.2 GHz input stage

or 7 digit accuracy. For 6 digits the measuring time is less than 0.2 s, and if 7 digit accuracy is chosen (which means a ten-fold improvement) the measuring time is ten times as large so it is less than 2 s. When pulse time measurement is selected the meter must still be told whether the '0' or '1' time is to be measured. This just leaves the choice of positive or negative slope in the event count mode. This selection simply determines whether the counter reacts to rising (positive) or falling (negative) edges of the input signal.

That covers all the frequency counter's functions but there are still two buttons that have not been dealt with. The 'LAST' button is used to jump back (as figure 6 indicates). If an error is made during selection the LAST button can be pressed to move one step backwards. The function of the 'HOLD/RESET' button is not indicated in the menu. When this button is pressed once the read-out is frozen and no more readings will be made. The indicator LED above the button then lights. Pressing HOLD/RESET again sets the display to zero and the meter starts counting again.

As we said at the beginning of this section the frequency counter is very simple to use because it lends the user a helping hand. That entirely justifies the brevity of these 'operating instructions' as you will soon see when you start using the meter. ■

Microphone extension cables are typical sources of noise. Signal losses caused by such cables are normally compensated by an input preamplifier, but this also amplifies the noise generated in the cable, as well as any random noise picked up by the cable. For those cases where the extension cable exceeds, say, one or two metres, it seems sensible to amplify the microphone signal *before* and *after* the cable. The advantages of this suggested configuration are a much improved signal-to-noise ratio and more effective hum suppression.

# microphone preamplifier

with symmetrical signal transfer

The proposed circuit consists of two parts, of which one is inserted between the microphone and cable and the second terminates the cable at the other end. A block schematic of the set-up is shown in figure 1. The signal from the microphone is therefore amplified by 20 dB before any cable-induced noise or hum is superimposed onto it.

The two amplifiers are connected by a two-core individually screened cable, which further reduces hum and noise pick-up. Note that the required power for the first part of the circuit (A) is supplied via the cable; this keeps the weight at the microphone as low as possible.

The second part of the circuit (B) amplifies the signal by a further 12 dB to make it suitable for driving the power amplifier via the TAPE, TUNER, or AUX terminals.

Normally, one of the terminals of the microphone inset is connected to earth while the other is used as the signal output. This would also have been possible with the output of the 20 dB amplifier: one of the cable conductors would then have served as signal line and the other as the earth line. We have, however, opted for a different set-up: one of the amplifier outputs, 1 (+), carries the normal signal; the other, 2 (-), the phase-inverted signal. If nothing further were done, the output of the 12 dB amplifier would be zero, because the two anti-phase signals would cancel one another. The phase-inverted signal is, therefore, inverted again and

added to the signal on the other line. All this is clearly illustrated in figure 1.

Why go to all this trouble? Because the noise signals on the second line are also inverted in the 12 dB amplifier and added to the noise signals on the first: as they are in anti-phase, they cancel each other to a large extent!

## The circuit diagram

Parts A and B of the block diagram are easily recognized in the circuit diagram in figure 2. The 20 dB amplifier is built around transistors T1 and T2; the extension cable is connected between 1 and 2 and 1' and 2' respectively; the 12 dB amplifier comprises transistors T3...T5 and associated components.

Transistor T1 amplifies the microphone signal about tenfold. The gain factor is primarily dependent upon the ratio R6/R5. If, for instance, the microphone signal is around 10 mV, the collector voltage of T1 will be about 100 mV.

Transistor T2 applies the signal at the collector of T1 to the extension cable twice: normal to 1 and phase-inverted to 2. Note that the collector and emitter resistors of T2 are located in the 12 dB amplifier (R8 and R9 respectively). As the two resistors are identical, the signals at the collector and emitter have the same level, but are opposed in phase.

RC network R7/C3 is a low-pass filter which prevents any signal feedback to the input stages.

Figure 1. Block schematic of the two parts of the preamplifier connected by a two-core individually screened cable.

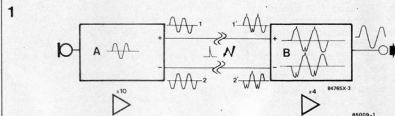

850C9-1

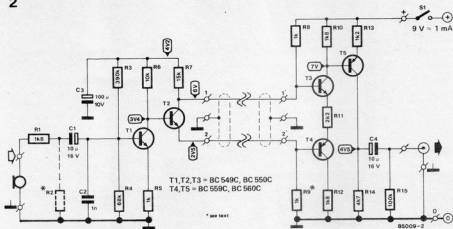

microphone preamplifier

Figure 2. The circuit diagram of the preamplifier: this has been kept as simple as possible to enable particularly the 20 dB amplifier to be built into the microphone housing.

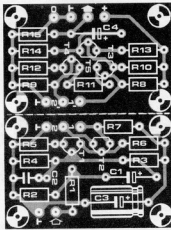
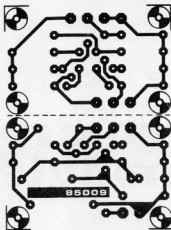

Transistors T3 and T4 serve to invert the phase of the signals on one of the lines, and to add the two signals together: the latter is effected by common emitter resistor R1.

The signal at the collector of T3 is applied to T5 which amplifies it fourfold. The amplifier signal is then applied to the output via a high-pass filter which prevents any direct voltage reaching the output. Resistor R2 serves to match the microphone output impedance to the transistor input impedance. You will remember that optimum performance ensues if the input impedance of the amplifier is equal to, or somewhat greater than, the output impedance of the microphone. In the circuit in figure 2, the input impedance is determined primarily by the resulting value of R3 and R4 (which are effectively in parallel): as shown this value amounts to 57 kΩ. If this value is too different from the microphone impedance, it may be lowered by R2. For instance, if, in the example given above, R2 is given a value of 100 kΩ, the input impedance of the amplifier would reduce to 36 kΩ.

### Construction

The printed circuit board for the two amplifiers is shown in figure 3: this should be cut before assembly. Ideally, the part for the 20 dB amplifier should fit in the microphone housing, but in many cases this may not be possible (the corners of the board may, of course, be rounded with a file to make it easier to fit, but be careful not to damage the tracks!). Otherwise the amplifier should be housed in as small a metal box as possible and mounted close to the microphone. Ideally this should be done by means of a plug and socket. In any case, make sure that the earth connections between the units and the screen of the cable are sound.

The part for the 12 dB amplifier will, we feel sure, give no trouble in being fitted inside the power amplifier or mixer unit cases. It will normally also be possible to tap the required supply voltage in these units.

Figure 3. The printed circuit board for the preamplifier: note that this should be cut before assembly.

### Parts list

Resistors:  
R1, R10, R12 = 1kΩ  
R2 = see text  
R3 = 390 k  
R4 = 68 k  
R5, R8, R9 = 1 k  
R6 = 10 k  
R7 = 15 k  
R11 = 2k2  
R13 = 1k2  
R14 = 4k7  
R15 = 100 k

Capacitors:  
C1, C4 = 10 μ/16 V  
C2 = 1 n  
C3 = 100 μ/10 V

Semiconductors:  
T1, T2, T3 = BC 549C or BC 550C  
T4, T5 = BC 559C or BC 560C

Miscellaneous:  
S1 = SPST switch  
2-core, individually screened audio cable as required  
PCB 85009



Photo 1. For our tests and evaluation we used a Multiplex 'Royal mc'. The transmitter can be switched between pcm and pdm. The basic version has four channels and may be extended to up to fourteen functions. Adaption to the control characteristic of different models is possible by means of a 'sort module' (ROM).

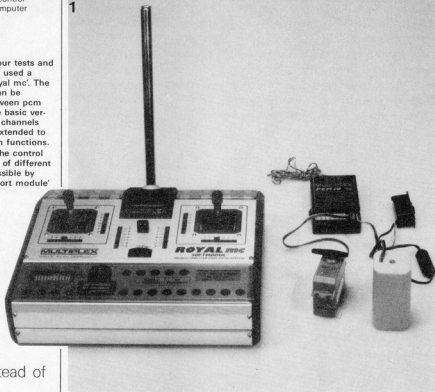

PCM instead of  
PDM

# remote model control with a microcomputer

As was to be expected, it has not taken very long after the microcomputer began to be used in good-quality portable radio receivers for it to encroach upon remote model control systems. Remote control using pcm (pulse code modulation) is a typical microcomputer application: a long overdue innovation.

In binary pulse code modulation only certain discrete values are allowed for the modulating signals. The modulating signal is sampled and any sample falling within a certain range of values is given a discrete value. Each value is assigned a pattern of pulses and the signal is transmitted by means of this pattern (code). In remote control, the transmitted signal corresponds to the position of a joystick.

## PDM — the conventional method

Pulse-duration modulation (pdm) is a form of pulse-time modulation (ptm) in which the time of occurrence of the leading edge or trailing edge is varied from its unmodulated position. In remote control systems, the joystick potentiometer is made part of a monostable multivibrator

(MMV) circuit. With the joystick in its centre position, the MMV generates pulses of 1.5 ms duration; at the two end positions of the control column, pulses of 1 ms and 2ms respectively are produced. In multi-channel equipment (each channel) requires a joystick potentiometer, the MMVs operate sequentially so that in each run (or cycle) a pulse train is generated. After each run (or cycle), the transmitter arranges an interval of 10 ms before the next cycle can begin. This is how the modulating signal in figure 1 is produced. The interval is needed for the synchronization of the decoder in the receiver: it 'warns' the decoder that a new cycle is about to start. The decoder then arranges for the incoming pulses to be directed to the appropriate servos: the first pulse to servo 1, the second to servo 2, and so on. A regulator

circuit in the servos ensures that the servo is driven in accordance with the duration of the received pulse.

### PCM — the modern method

Like other digital computers, the micro cannot work with the analog values (of current, voltage, resistance) emanating from the joystick(s); it needs binary digits, bits, at one of its input ports. The proven means of converting a continuously varying (analog) signal into a series of bits is a digitizer also called analog/digital converter.

Unfortunately, analog/digital converters are relatively expensive, so it is not feasible to connect one to each joystick potentiometer. As in pdm systems, the signals at the various potentiometers in the control levers are passed sequentially to the analog/digital converter: this is called multiplexing. As each scanning cycle takes several milliseconds, there are no speed problems associated with the digitizer.

If you already have pdm equipment, you do not need an analog/digital converter because the pdm signal (figure 1) is already digital. This digital signal is then fed to one of the serial ports of the microprocessor and the micro then simply evaluates the pulse durations. The counter

position at the end of the pulse is the binary value for that particular potentiometer. This solution is suitable for equipment that can be switched between pdm and pcm so that the new transmitter can still work with existing pdm receivers. An 8-bit analog/digital converter provides up to  $2^8$  (= 256) binary numbers. This means that, functionally, the joystick potentiometer may be compared to a rotary switch with 256 positions, so that the relevant servo may assume 256 different positions. This is illustrated in figure 2. The graduated disc above the servo shows the relation between the servo position and the 8-bit binary word (= byte). The rectangular pulses illustrate a portion of the received pcm signal. A servo fitted with a step motor and relevant control could be driven direct by the byte, but such servos are (not yet) available in the retail trade. To drive conventional servos, the pcm decoder in the receiver must convert the pcm signal into control pulses of variable width (pdm).

### Circuit technique

We shall use the circuit diagrams of Microprop's pcm equipment as an example: the transmitter diagram is shown in figure 3, that of the receiver in figure 4.

Starting with the transmitter, at the left in

remote model control with a microcomputer

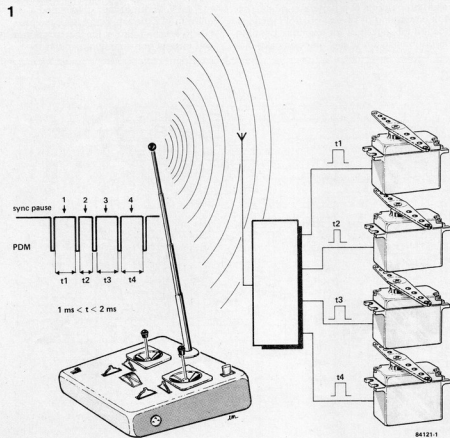

Figure 1. Conventional digital pdm system. The servo position is determined by a pulse of definite duration (1...2 ms).

2

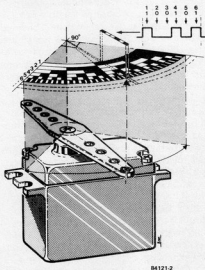

Figure 2. With pulse code modulation (pcm), the servo positions are divided into discrete steps. Each servo position is determined by a binary number consisting of 8 or 9 bits.

Figure 3. Circuit diagram of the Microprop pcm transmitter in which the different functional blocks are clearly identifiable. At the left, the controls (joysticks, and so on), then the analog/digital converter, and next the single-chip microcomputer. At the top right the supply regulation and at the bottom right the battery monitor circuit with alarm buzzer.

figure 3 are the joysticks, slide potentiometers, presets, and channel switches. Between these components and the analog/digital converter is a 64-way connector which enables the insertion of a special module. Such a module contains a variety of potentiometers and a number of operational amplifiers and makes it possible to preset, for instance, the trim or steering controls of a particular model, or the combining of several control functions (called mixing). It is, for example, possible in the transmitter to mix electronically the

height and rudder functions of the tail unit. The module also enables the modification of the control characteristic, for instance, from linear to exponential. The voltages from the control elements are applied to the eight inputs of IC3 via operational amplifiers (opamps). This circuit contains the multiplexer and the analog/digital converter. The clock for the switching of the inputs and of the analog/digital converter is provided by microprocessor IC6. This single-chip device, a CMOS version of Motorola's 6805, is also fed with the data from the digitizer via the data bus. It is also possible to connect eight switches to this bus via the nautics socket; the micro will then scan the signals from these switches instead of the information on channel 5 when switch S5 is closed. The micro processes the 8-bit data words into a serial (pcm) signal on pin 5, which is a combination of the data words and additional test or synchronization bits. This signal is then fed to the input connector of the h.f. module (which contains the transmitter proper) via a buffer type BC 239.

The RESET switch connected to pin 17 of the micro does not serve to reset the transmitter computer, but to switch off for 10 seconds the low-voltage warning function in the receiver!

A simple voltage regulator (right-hand top) consisting of an opamp, zener diode, and a regulating transistor provides the circuit with +5 V. Three further opamps contained in IC7 (bottom right) form the low-voltage warning circuit for the transmitter. Total current consumption amounts to

3

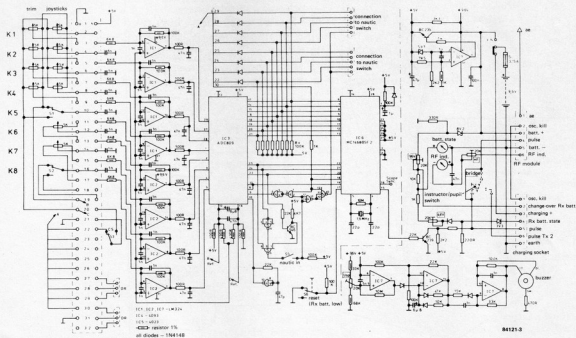

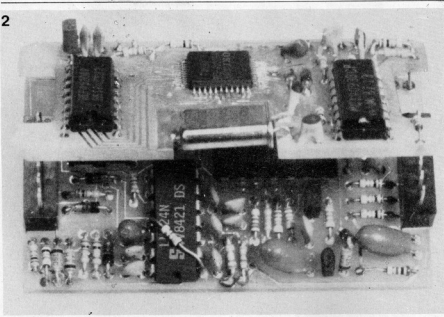

about 150 mA — without the h.f. module around 50 mA. The decoder board of the receiver (figure 4) contains a microprocessor identical to that in the transmitter, but differently programmed, of course. The r.f. part of the receiver, contained on a separate board, complies with the normal standard requirements for fsk (frequency-shift keying) remote control systems: no r.f. amplifier, an S042P as mixer/oscillator (quartz controlled), a 455 kHz selective band-pass filter, and an S041P as

limiter/demodulator/amplifier. The signal from the r.f. section is first amplified in two of the four opamps in IC3 and then reshaped to rectangular pulses before it is fed to a bus input (pin 6) of the microcomputer. The other seven inputs of the micro are not used and are connected to +5 V. As in the transmitter, a simple power-on-reset circuit is connected to pin 1. All further processes are carried out within the chip under the control of the software; the outputs of the micro are taken direct to the servo connectors. The servos are

Photo 2. The pcm coding module in the Webra transmitter, in which another 80C48 carries out almost all the work. There is no separate analog/digital converter and other peripheral components have also been kept to a minimum.

Figure 4. Circuit diagram of the Microprop pcm receiver which is built onto two PCBs. The top part shows the f.m. receiver, a simple superhet with mixer IC, ceramic filter, and demodulator IC. The lower board contains the decoder and the single-chip microcomputer which is of the same type as that in the transmitter but, of course, has been programmed differently. The micro's outputs drive up to eight servos direct by means of variable-width 1...2 ms pulses. Two opamps amplify the received pcm signal and convert this into rectangular pulses for driving the microcomputer. IC4 doubles the battery voltage which is then stabilized at 5 V by a further opamp. The fourth opamp contained in IC3 monitors the battery voltage.

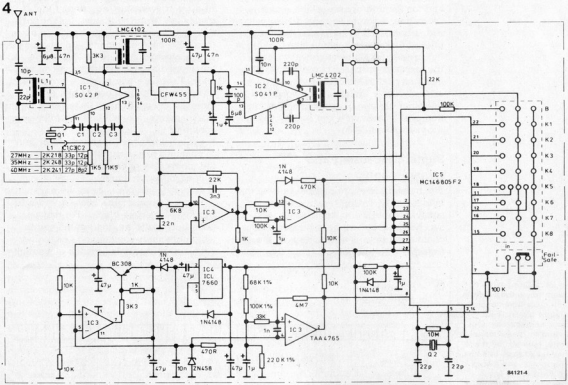
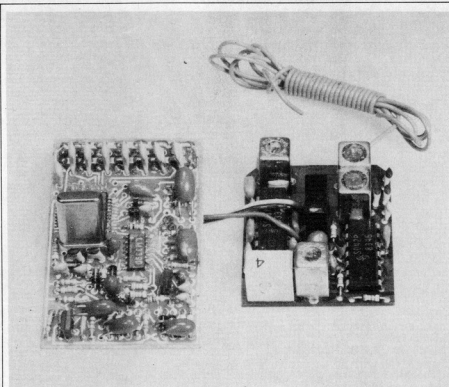

Photo 3. Webra's receiver and pcm decoder. The receiver is based on the well-known S041P and S042P. The decoder circuit consists basically of OKI's CMOS processor type 80C48, which is located under the 3.88 MHz quartz crystal on the decoder board. The second chip is a four-stage comparator type LM 339. The eight servos are connected direct to the 80C48.



controlled by variable-width pulses. The 4.8 V receiver battery (four NiCd cells) is connected to terminal B. To ensure a supply of 5 V, the battery voltage is doubled by IC4 and then stabilized at +5 V by IC3 and a type BC 308 transistor. Zener diode ZN458 provides a reference voltage of 2.45 V for the voltage regulator and for a fourth opamp which monitors the battery voltage. As soon as that voltage drops below 4.5 V, the opamp makes pin 8 of the micro logic 0 which starts the warning procedure. Current consumption of the receiver proper is about 35 mA while each servo draws a quiescent current of around 10 mA. Thanks to the voltage doubling, the receiver continues to function satisfactorily until the battery voltage drops to about 3.4 V.

### Signal processing and transmission

The transmitter micro composes from the byte from the analog/digital converter a serial signal that also contains any test or synchronization bits. In some equipment a channel address is also added. In the example given in figure 5, each 8-bit data

block is followed by the relevant channel number (3 bits for channels 1...8), a parity bit, a stop bit, and a sync pulse. After one cycle (eight blocks for channels 1...8) has run, the next cycle starts with channel 1 again. If you add all the bits together, you will find that there are 104 bits per cycle, excluding the sync pulses. In most conventional equipment the cycles last 20 ms so that with eight channels the transmission rate becomes more than 5000 bits per second. This means that with a channel spacing of 10 kHz, the transmitted r.f. bandwidth becomes too wide. There are two possible solutions to this: reduce the number of bits or increase the cycle time. Depending on the manufacturer, you will find the following solutions:

- **priority channels** — only three or four channels are transmitted each cycle; the others less often, for instance, each second or fourth cycle;
- **priority principle** — here the transmitter micro composes the cycle in order of priority of the data blocks. For that purpose it needs to be first established in which channels something is changing. Such active channels (joystick movement)

Figure 5. Composition of a pcm transmission cycle. Each cycle here consists of eight blocks. Each block contains the information for one channel in 8 bits, followed by the channel address in 3 bits, a parity bit, and a stop bit. Each block is followed by a sync(ronization) pulse.

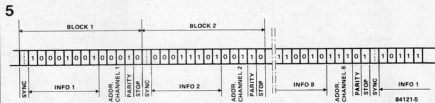

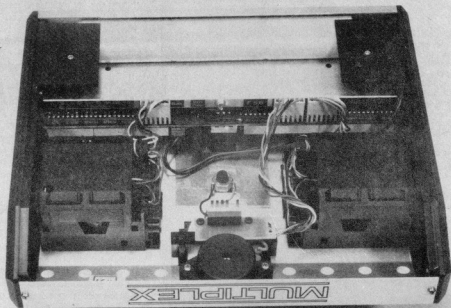

are transmitted more frequently and the others only every second or fourth cycle.

■ *longer cycle time* — all channels are transmitted in fixed order; the cycle frequency drops therefore to about 20 Hz. Recently, Japanese equipment (JR and Futaba) has become available that uses a different solution: they operate with 9-bit data words, do not use priority channels or the priority principle, and yet operate at 50 full cycles per second. The Japanese have apparently developed a time-saving coding system!

Signal transmission from transmitter to receiver takes place as in conventional pdm equipment by frequency-shift keying (fsk); most manufacturers use the same r.f. module. The pcm signal from the micro is filtered to round the edges and is then used to modulate the carrier via a varicap. The receiver also uses the f.m. standard. Receivers with gain-controlled r.f. amplifiers are just beginning to become available. These are long overdue because, after all, receiver characteristics such as the signal-to-noise ratio, selectivity, and sensitivity are just as important here as in most other receivers and they are certainly ripe for improvement. It should also be borne in mind that the microcomputer cannot improve the r.f. performance of the receiver, although it can detect transmission errors by means of the test bits. Depending on the manufacturer, the micro tests single data blocks or whole cycles at parity. At least one manufacturer (Microprop) relies on a cyclic redundancy check (CRC). If data are suspected of containing errors, they are not passed on to the servos, although error correction is not available. As long as correct information

does not become available, the servos retain the status quo. None the less, after 0.5...1.5 seconds (depending on manufacturer), the micro takes emergency measures.

### Action in emergency

All pcm receivers have a more or less 'clever' fail-safe program. In the simplest case, the servos remain in the last correctly received position. An alternative is to slow down the engine or set the servos to neutral. In most receivers it is possible to choose between these alternatives. Additionally, some Japanese equipment and also the Austrian Webra pcm unit offer the model aviator the possibility of establishing his own emergency measures and store these in the transmitter micro. When the system is switched on, the measures are then cyclically radiated, stored in the receiver, and acted upon in an emergency.

The receiver also reacts to the dropping of the battery voltage below a certain level as to an emergency. The most rabid computer reaction is the slowing down of the engine or the application of the brake flaps in gliders. Rather less drastic measures are also possible: with these it is generally possible to determine yourself which function to trip at low battery voltage. Futaba and Webra allow the model aviator to switch off the tripped low-voltage warning function at the transmitter and to land the model without inhibition of any control function.

### PCM in practice

PCM equipment with 8-bit resolution moves its servos in small but clearly

Photo 4. The inside of the 'Royal mc' transmitter is quite neat. The r.f. part has been designed as a plug-in module.

Photo 5. Measurements in the receiver: at the top the output signal to a servo, a variable-width pulse which is fed to the servo every 25 ms. Below, the pcm signal at the input to the microcomputer in the pcm decoder: a constant stream of bits at the rate of 2500 bps (bits per second).

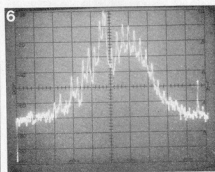
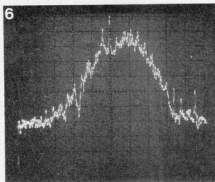
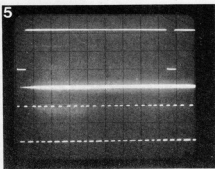

Photo 6. At the top the r.f. spectrum of the Multiplex 'Royal mc' transmitter switched to pcm operation. As a comparison, the spectrum of the same transmitter switched to pdm operation is given below. The horizontal scale is 2 kHz per division and the vertical is 10 dB per division.

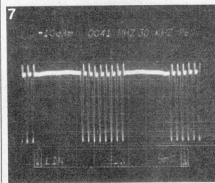

Photo 7. The modulation signal in pdm operation.

discernible steps, accompanied by a soft, purring noise. The quantization error of 0.4 per cent is of the same order as the positioning accuracy of the best servos (under no-load conditions). With 9-bit resolution, the error can no longer be determined: the servos run just as smoothly as with pdm.

Different assessments by the manufacturers bring about different methods of limiting the transmitter bandwidth. Equipment with 'faster' priority channels, for instance, is not quite suitable for applications where mixing functions are important (as in expensive gliders and helicopters). Practical competition pilots with their equally practical models will detect in Multiplex and Webra equipment a small, but noticeable delay in response which can be traced back to the reduced cycle frequency.

What is undoubtedly a very positive factor in a pcm system is its facility for suppressing interference. The total absence of the dreaded 'servo wobble' gives pilots greater confidence in critical situations as, for instance, in low-level fly-overs at high speed. Also, there is no longer the danger of a near-by operating transmitter upsetting things when the model is taxiing. There is also a negative aspect in that when the limit of the operating range is reached, this is no longer indicated by 'wobble'. A pcm-controlled model reacts either correctly or not at all. There is no 'grey area'.

Confidence is further strengthened by the low-voltage warning circuit, although a drastic slowing down of the engine as a warning signal can lead to awkward situations. In this respect, warning signals that the pilot can establish himself and which can be disabled via the transmitter are much to be preferred.

Many are the arguments as to the sense and nonsense of the various fail-safe programmes, although most experts do not rate the probability of a complete rescue very high. When the transmitter fails, or there are very strong interfering signals, even pcm-controlled models can crash, although they do so more neatly than others: in tight bearing with definite control settings and slowed down engine!

## Summary

The most laudable aspect of pcm systems is the inherent interference suppression which completely obviates uncontrolled servo flounder. Battery monitoring in the receiver is also a welcome plus point. The various fail-safe programs are of considerable technical interest, but their practicability is as yet questionable.

In all fairness, it should be said that current first-class conventional equipment has reached a high degree of sophistication and is in practice wholly adequate. But pcm is more up-to-date and, when its price comes down to that of conventional equipment, offers a little more for your money. It should not take all that long before the microcomputer will also be available in inexpensive remote control equipment.



It is very frustrating to be unable to complete a project or use some equipment for lack of the right connector. This happens to everybody including Elektor designers in spite of the great variety of connectors we have at our disposal. When we came up against this problem we felt the need to do something about it and rummaging around in a 'junk' box found just what we needed.

## d.i.y. connector

These days there are norms for virtually everything. The most common standards for connectors are DIN (German standards association) and the new SCART (described in the October 1984 issue of Elektor India). Even modern equipment does not always conform to norms, however, and this can cause problems. Difficulties can also arise if you cannot resist that 'bargain of the century' but find that it has a completely unique type of connector. Provided this is a female connector there is a solution. This is what to do:

- Start by finding a suitable type of contact or pin to suit the size of the female connector and that will provide a good electrical contact when inserted.
- Cut a piece of perspex about 3 mm thick to almost the same dimensions as the connector. This should be made slightly oversize to ensure a tight fit.
- Drill guide holes in the appropriate positions using a bit that is about 0.3...0.5 mm smaller in diameter than the pins chosen.
- Place the perspex in a vice and close the jaws (but not too tightly).
- Push the pins into the perspex one at a time by heating them with a soldering iron. The guide holes will now melt to the right size.
- A pliers can be used to make slight adjustments to the positions of the pins if they are heated again. This technique, as you will have noted, can only be used to make male connectors. The result is shown in photo 1. If the connector to be made has a standard layout the matter is simplified somewhat:

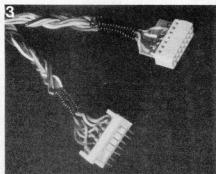
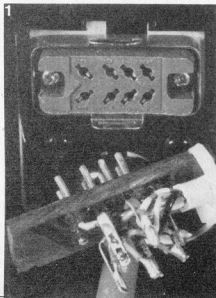

- Take a length of prototyping board with holes spaced at 0.1 inch (2.54 mm) and solder the pins at the appropriate places. That is all there is to it! Note that there are European connectors (31-pin, for example) with the pins spaced at 2.5 instead of 2.54 mm. These two types are not compatible. Male connectors can be made for most types of female sockets. A few different types are shown in photo 2, to give some idea of the options.

### Two connectors for the price of one

There is sometimes a need for a female edge connector with 2.54 mm spacing (as in the CPU card published in November 1983). These are becoming more common but you may not have one when you need it. The answer might be found in your junk-box, in the form of a 34-way connector salvaged from a ribbon cable. Two connectors, with up to 16 ways each, can be made from this.

- Cut the 34-way connector in half with a hacksaw or something similar. This renders the two centre connectors useless. If necessary trim each half to the correct number of ways.
- File the cut ends of each section.
- Solder the wires of a multicore or ribbon cable carefully to the appropriate pins.
- Spread a thin layer (about 1/2 to 1 mm) of two-component glue between the two rows of pins.
- Fix the cables in place with a few drops of two-component glue. Make sure the glue used does not attack the insulation on the wires. Apply several thin layers of glue until the ends of the wires are fully encased. When this is finished the result will be like the example shown in photo 3: a simple-to-make but virtually indestructible connector.

the art of making your own connectors

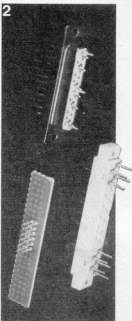

convert your  
micro-computer  
into a

Most personal computers on the market today have at least one 'voice': a sound generator, in other words. The circuit here is something completely different. It is more a matter of computer control than microprocessor-generated sound. The computer controls eight generators, each of which provides the sound of a particular percussion instrument. The ZX81 is used as an example to show that the computer controlling the drum box does not have to be very sophisticated or have a large memory in order to perform a useful task.

# programmable rhythm box

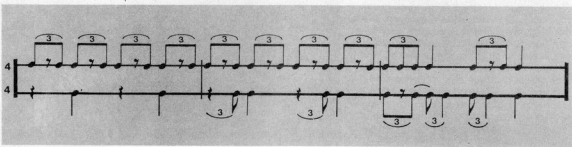

Eight-bit micro-computers can be used to perform many tasks, even, as is the case here, play an electronic drum set. The procedure involves generating a sequence of data whose binary configuration (the order of '1's and '0's) triggers the different noise generators in turn. The data determines the rhythm and tempo of the total sound generated. Each of the eight output data bits that make up the control word corresponds to the control input of one instrument. This is indicated by table 1. If the data word were 0000 0001, for example, a single instrument, the bass drum in this case, is triggered.

If the binary control word is 0000 0000 nothing will be heard as no instrument is triggered. If the control word is 1111 1111 all the instruments will be triggered. The result in this latter case will be just a confusion of noise as no more than three or four instruments can be triggered at a time without introducing distortion.

One essential part of the drum box is the eight noise generators, the other essential is the eight-bit control word provided by a computer. The word appears directly on the ZX81's data bus but may have to travel via an output port (VIA, PIA, PIO, etc.) in the case of other computers. The program makes use of arrays, the number of

elements of which is determined beforehand using the DIM instruction in BASIC. The number of elements in the array decides the length of the rhythmic sequence that must be repeated. A simple POKE command is used to apply the data word to the noise generator circuits. The use of BASIC does not really limit the speed at which the rhythms are executed.

## The interface

The interface between micro-computer and sound generator is shown in the circuit diagram of figure 1. The section in the box is the address decoding circuit that is specific to the ZX81 and has the Elektor bus pin configuration. The logic level of line A0 is not examined so the circuit is active at both 3FE0<sub>HEX</sub> and 3FE1<sub>HEX</sub> (16352 and 16353 respectively in decimal). The logic level output from N10 when one of these addresses appears on the address bus is combined with the logic output of N12, which is low when control lines MREQ and WR are both '0'. In this way N11 outputs the enable signal for the interface.

In a 6502-based system the MREQ and WR signals are replaced by the single RAM R/W signal. The address decoding must be modified to suit the particular circumstances by means of inverters N1...N5 and gates N7...N9.

The addressing signal output from N11 triggers monostable multivibrator N15/N16. This in turn controls an indicator LED via N13 and N14, the parallel combination of which satisfies the LED's current requirement. Every time the circuit is addressed (when at least one instrument is triggered) the LED lights. This gives a visual indication of the tempo. The same enable signal also controls octal flip-flop IC5.

H. de Lange

Table 1. Each control data bit output by the micro-computer corresponds to the input of an instrument generator. Each generator is active when its input goes from '0' to '1'.

Table 1.

instruments	snare drum	maracas	claves	cymbal	low bongo	high bongo	conga	bass drum
bits	7	6	5	4	3	2	1	0
	control word							

When the CLK input detects a falling edge the 74LS374 passes the word present on the computer's data bus to electronic switches ES1...ES8. If the data word is fed through a programmable output port in the computer the octal flip-flop is unnecessary and can be left out.

Each of the eight data bits controls an electronic switch (via IC5). Experience has shown that using these switches (which might appear superfluous) is an effective way of reducing the intermodulation between the various instruments. In addition to this the high impedance of these switches when they are open effectively suppresses the sound generated by the instruments. What it all adds up to is that the switches improve the circuit's signal to noise ratio (in this case we could call it the noise to silence ratio).

The width of the control pulse, as we will see shortly, effects the sound of some of the instruments. The instruments are controlled by the signals BD (bass drum), CD (conga drum), HB (high bongo), LB (low bongo), LC (long cymbal), CL (claves), MR (maracas) and SD (snare drum).

## The generators

Three different types of noise generator are shown in the diagram of figure 2. They provide:

- muffled oscillation at a given frequency
- filtered (or coloured) white noise
- mixture of filtered white noise and muffled oscillation.

The muffled oscillation is produced by double-T oscillators triggered by the control pulses. The loop gain of these oscillators, each of which is based on a NAND gate, is controlled so that it is insufficient for oscillation to continue. The degree of muffling therefore varies with the gain. The frequency of each of this type of oscillator is determined by the values of capacitors C2, C3 and C5 in each case. The output amplitude of every module is fixed by the value of resistor R8. The gain, and consequently the degree of muffling, can be changed by means of preset P1.

The source of the white noise, T2, feeds the filtering circuit for the cymbal sound via C8. The actual filtering is carried out

programmable rhythm box

Figure 1. An octal TTL flip-flop is used here to latch the data input from the computer. The address decoding will have to be changed if any micro-computer other than the ZX81 is used with this rhythm box. Note that the pin designations correspond to the Elektor bus.

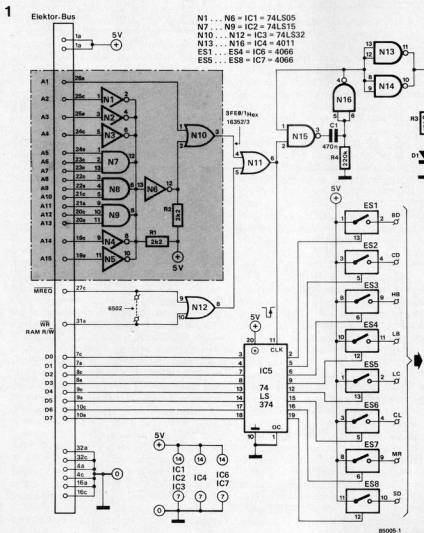

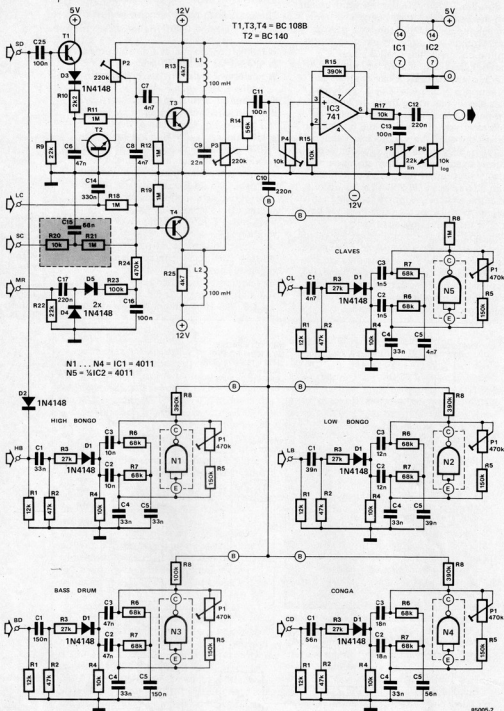
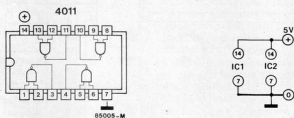
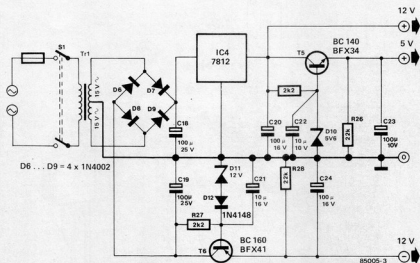

Figure 2. The actual rhythm box consists of five double-T oscillators (N1...N5), each of whose muffled frequency has the characteristics of the instrument that is to be imitated, a white noise generator (T2) and two colouring networks for this white noise in the collector circuit of T3 and T4. The signals are summed at point B and the wiper of P4.





by L2 in parallel with R25, the combination of which tends to amplify high frequencies. Depending on whether the control pulse is applied to the LC or SC input the cymbal sound will be long or short. The attack (rise) will always be very sharp and the decay (fall) will be long or even longer. The maracas sound is also generated using the same filtering circuit but the control signal (MR) is distorted so that the attack is progressive as this sort of instrumental demands. The snare drum sound is achieved using an oscillator (the high bongo's as it happens) and a noise filter. The SD control pulse is shaped by the circuit around T1. The white noise is coloured by means of R13, L1 and C9. The pulse is also fed to input A of the high bongo oscillator via D2, which prevents the HB signal from activating the snare drum's noise circuit.

The amplitude of the white noise signal applied to the filters is fixed once and for all with preset P2. The amplitude of the noise signal that figures in the snare drum's sound is determined by preset P3. The final mix of muffled oscillations and white-noise-based sounds is made by the wiper of preset P4. This, in fact, sets the input level of op-amp IC3. The output level can be varied with pot P6, while pot P5 allows the tone (actually the attenuation of the high frequencies) to be corrected.

### The power supply

A suitable power supply for the rhythm box is shown in figure 3. If the controlling micro-computer can supply the necessary voltage and current (at least 100 mA at 12 V) the power can be tapped directly from it and the circuit of figure 3 can be omitted.

Two different printed circuit board designs are used for this drum box. The main board is shown in figure 4, and figure 5 shows the design that can be used for each of the five 'instrumental' modules. The photograph shows how the six boards fit together. The final result is a compact unit that can easily be accessed. The signal output by the rhythm box is not yet audible, of course. It must be amplified and fed to one or more loudspeakers. A telephone amplifier is quite sufficient for test purposes but will not reproduce all the sounds faithfully. Be careful about going to the opposite extreme however. If you feed the signal from the drum box into your hi-fi system keep the volume low. Even muffled the oscillations pack quite a punch.

### The software

As yet the rhythm box cannot do anything. Without control signals the generators remain mute. The duration of the control pulses has no effect on the oscillators but the noise generators, on the other hand, do remain active as long as the corresponding control line is high. The program of table 2 allows eight 'classical' rhythms to be generated. Each of these has a corresponding table, seven of which consist of 16 elements (the quavers making up two bars in four-four time). The table for the waltz, which is in three-four time, has only 6 elements. Each of these elements, A (C), is a control data word whose binary configuration activates one or more of the instruments. The control word is reset to zero regularly in a FOR-NEXT loop (E), the duration of which also decides the tempo. Line 440 causes the FOR-NEXT loop (C) to repeat

Figure 3. If the micro-computer cannot provide the power supply for the drum box the circuit shown here can be fitted to the printed circuit board shown in figure 4. Make sure voltage regulator IC4 is fitted with the right polarity.

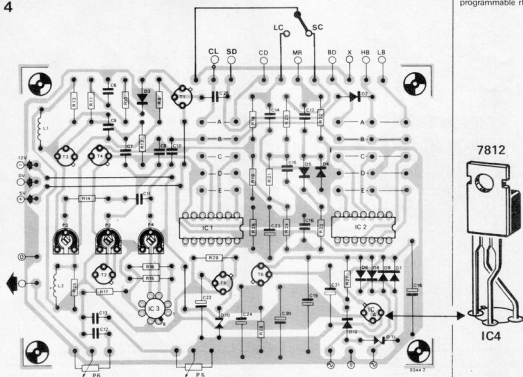

7812

IC4

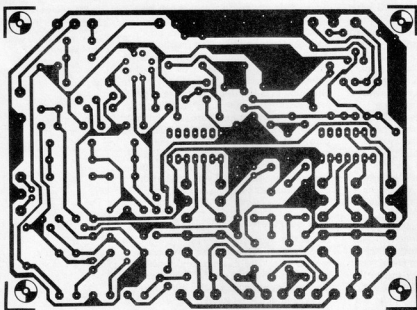

85005-4

Figure 4. This printed circuit board (which is not available from Elektor) can be used to make the rhythm box. The pin-out of IC4 used on the board is different from that of current 7812s: the blow-up shows the way this should be mounted.

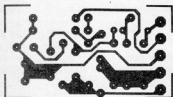
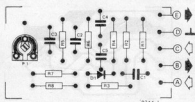

85005-5

Figure 5. The components comprised in the double-T oscillators fit onto five printed circuit boards like this one, except for the NAND gates in IC1 and IC2 on the main board. Like the main board this one is not available from Elektor. The values of the components that are specific to each instrument are shown in figure 2.

10 PRINT "1 = BEAT	2 = WALTZ"	2140 LET A(13) = 33	3610 LET A(10) = 16
20 PRINT "3 = TANGO	4 = SAMBA"	2150 LET A(14) = 0	3620 LET A(11) = 144
30 PRINT "5 = BOSSANOVA	6 = ROCK AND ROLL"	2160 LET A(15) = 33	3630 LET A(12) = 147
40 PRINT "7 = BEGUINE	8 = HABANERA"	2170 LET A(16) = 48	3640 LET A(13) = 19
50 PRINT		2180 RETURN	3650 LET A(14) = 16
60 PRINT "CHOOSE A RHYTHM"		2500 LET D = 16	3660 LET A(15) = 144
70 INPUT A		2510 DIM A(16)	3670 LET A(16) = 16
80 PRINT A		2520 LET A(11) = 164	3680 RETURN
100 IF A > 8 THEN GOTO 60		2530 LET A(2) = 0	4000 LET D = 16
110 PRINT		2540 LET A(3) = 164	4010 DIM A(16)
120 PRINT "CHOOSE A TEMPO (1-10)"		2550 LET A(4) = 0	4020 LET A(1) = 21
130 INPUT B		2560 LET A(5) = 2	4030 LET A(2) = 129
135 FAST		2570 LET A(6) = 2	4040 LET A(3) = 1
140 PRINT B		2580 LET A(7) = 2	4050 LET A(4) = 144
150 IF B = 10 THEN GOTO 120		2590 LET A(8) = 164	4060 LET A(5) = 5
160 IF A = 1 THEN GOSUB 1000		2600 LET A(9) = 0	4070 LET A(6) = 129
170 IF A = 2 THEN GOSUB 1500		2610 LET A(10) = 36	4080 LET A(7) = 21
180 IF A = 3 THEN GOSUB 2000		2620 LET A(11) = 2	4090 LET A(8) = 129
190 IF A = 4 THEN GOSUB 2500		2630 LET A(12) = 36	4100 LET A(9) = 5
200 IF A = 5 THEN GOSUB 3000		2640 LET A(13) = 36	4110 LET A(10) = 129
210 IF A = 6 THEN GOSUB 3500		2650 LET A(14) = 0	4120 LET A(11) = 17
220 IF A = 7 THEN GOSUB 4000		2660 LET A(15) = 36	4130 LET A(12) = 129
230 IF A = 8 THEN GOSUB 4500		2670 LET A(16) = 0	4140 LET A(13) = 21
240 CLS		2680 RETURN	4150 LET A(14) = 129
250 PRINT "TYPE 1 TO STOP"		3000 LET D = 16	4160 LET A(15) = 5
260 FOR C = 1 TO D		3010 DIM A(16)	4170 LET A(16) = 129
270 POKE 16352, A(C)		3020 LET A(1) = 145	4180 RETURN
280 FOR E = 1 TO B		3030 LET A(2) = 16	4500 LET D = 16
290 POKE 16352, 0		3040 LET A(3) = 48	4510 DIM A(16)
300 IF INKEY \$ = "1" THEN GOTO 9000		3050 LET A(4) = 145	4520 LET A(1) = 6
310 NEXT E		3060 LET A(5) = 17	4530 LET A(2) = 49
320 NEXT C		3070 LET A(6) = 16	4540 LET A(3) = 49
440 GOTO 260		3080 LET A(7) = 176	4550 LET A(4) = 2
1000 LET D = 16	1520 LET A(1) = 1	3090 LET A(8) = 16	4560 LET A(5) = 6
1010 DIM A(16)	1530 LET A(2) = 0	3100 LET A(9) = 17	4570 LET A(6) = 49
1020 LET A(1) = 65	1540 LET A(3) = 128	3110 LET A(10) = 16	4580 LET A(7) = 4
1030 LET A(2) = 0	1550 LET A(4) = 0	3120 LET A(11) = 176	4590 LET A(8) = 49
1040 LET A(3) = 65	1560 LET A(5) = 128	3130 LET A(12) = 17	4600 LET A(9) = 6
1050 LET A(4) = 0	1570 LET A(6) = 0	3140 LET A(13) = 17	4610 LET A(10) = 49
1060 LET A(5) = 192	1580 RETURN	3150 LET A(14) = 144	4620 LET A(11) = 49
1070 LET A(6) = 0	2000 LET D = 16	3160 LET A(15) = 48	4630 LET A(12) = 2
1080 LET A(7) = 65	2010 DIM A(16)	3170 LET A(16) = 16	4640 LET A(13) = 6
1090 LET A(8) = 128	2020 LET A(1) = 33	3180 RETURN	4650 LET A(14) = 49
1100 LET A(9) = 65	2030 LET A(2) = 0	3500 LET D = 16	4660 LET A(15) = 2
1110 LET A(10) = 0	2040 LET A(3) = 33	3510 DIM A(16)	4670 LET A(16) = 49
1120 LET A(11) = 192	2050 LET A(4) = 0	3520 LET A(1) = 19	4680 RETURN
1130 LET A(12) = 1	2060 LET A(5) = 33	3530 LET A(2) = 16	9000 CLS
1140 LET A(13) = 64	2070 LET A(6) = 0	3540 LET A(3) = 144	9010 PRINT "ANOTHER RHYTHM (Y/N)"
1150 LET A(14) = 128	2080 LET A(7) = 33	3550 LET A(4) = 147	9020 INPUT F\$
1160 LET A(15) = 65	2090 LET A(8) = 48	3560 LET A(5) = 19	9030 PRINT F\$
1165 LET A(16) = 64	2100 LET A(9) = 33	3570 LET A(6) = 16	9040 IF F\$ = "Y" THEN GOTO 10
1170 RETURN	2110 LET A(10) = 0	3580 LET A(7) = 144	9050 STOP
1500 LET D = 6	2120 LET A(11) = 33	3590 LET A(8) = 16	
1510 DIM A(6)	2130 LET A(12) = 0	3600 LET A(9) = 19	

endlessly. Line 300, on the other hand, provides an exit from the loop (to change the rhythm, for example) by pressing key '1'.

Many BASIC compilers are familiar with the READ instruction which, in combination with DATA, enables the program to have a more versatile and elegant structure. If your computer has this command use it.

The program shown here can only provide very simple rhythms (two bars are all that is catered for). There is no reason not to extend the tables, however, to program more than two bars. With a bit of clever BASIC programming even breaks, fill-ins and other such features of style can be incorporated. **M**

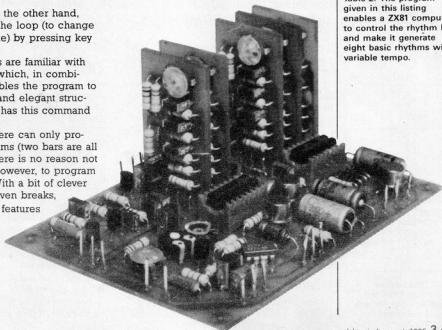
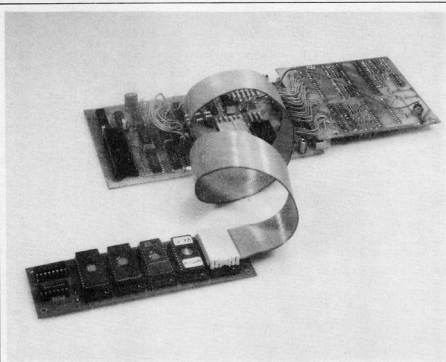

Table 2. The program given in this listing enables a ZX81 computer to control the rhythm box and make it generate eight basic rhythms with variable tempo.



Photograph. This shows the EPROM selector connected to the 6502 CPU board featured in the December 1983 issue of *Elektor India*.

# EPROM selector

four EPROMs in one address range

The main memory of a microcomputer has a remarkable property: when you buy the computer, the memory seems very large, but as time goes on it shrinks and shrinks, a phenomenon caused, of course, by your programs getting longer and longer... The circuit suggested here expands the memory but only insofar as EPROMs are concerned. Basically, it is a simple but effective 'soft switch' which is suitable for all EPROMs in the 25XX and 27XX families.

byte	hex		D1	D0	EPROM
	dec.				
0	0	0	0	0	1
1	1	0	1	2	2
2	2	1	0	3	3
3	3	1	1	4	4
4	4	0	0	1	1
5	5	0	1	2	2
6	6	1	0	3	3
7	7	1	1	4	4
8	8	0	0	1	1
9	9	0	1	2	2
A	10	1	0	3	3
B	11	1	1	4	4
C	12	0	0	1	1
D	13	0	1	2	2
E	14	1	0	3	3
F	15	1	1	4	4

Table 1. The relation between the EPROM enabled and the relevant software command.

Every computer user knows that it is not possible to just write data into an EPROM, but that this must be programmed suitably. But what prevents the writing of a data word into an address range in which the EPROM is situated? After all, you cannot damage anything; at worst, the program 'crashes'. With the present circuit you can intentionally write a data word in the EPROM address range: this will not affect the EPROM at all, but the decoding logic of the circuit will evaluate the information and on that basis select one of four EPROMs. That EPROM remains active until another one is selected by a fresh data word being written into the EPROM address range. All in all, a neat yet easily programmed solution to a frequent problem.

## The circuit

Of the five sockets shown in figure 1, EPROM1... EPROM4 are intended for the

additional EPROMs, while the fifth accepts a DIL plug into which a length of flat ribbon cable has been connected. The other end of the cable is also fitted with a DIL plug which is inserted into the original EPROM socket in the computer; that EPROM itself is plugged into one of the EPROM sockets 1...4.

The circuit is contained on a PCB which, with few exceptions, connects the identical pins of the sockets together. Connections shown in brackets refer to 24-pin EPROMs, all others to 28-pin EPROMs. Exceptions are:

- terminals OE (output enable) of EPROM sockets 1...4 are connected to the selection logic, which ensures that only one of the lines is logic 0 at any one time and therefore that only the selected EPROM is actuated;
- pins 20 and 22 of the master socket are connected to a wire bridge (pin 20 is also connected to pins 20 of the other





3

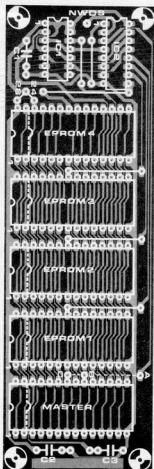
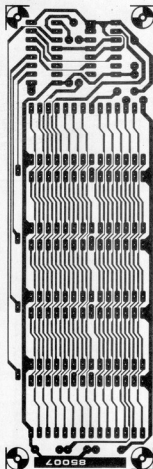

## Parts list

C1, C2 or C3 = 100 n\*  
 IC1 = 74LS74  
 IC2 = 74LS139  
 PCB 85007  
 5 sockets, 24-pin or 28-pin  
 as required — see text  
 2 DIL plugs, 24-way or  
 28-way, as required, with  
 spring-loaded contacts  
 ribbon cable, 24-way or  
 28-way, as required.

\* = total 2, see text

Figure 3. The printed circuit board of the EPROM selector.

The inputs of the bistables are connected with data bus lines D0 and D1. During time T3, the computer is instructed to write into the EPROM range — this may, for instance, be through a POKE command. The NWDS and OE lines first become logic 0 and then go high again. This actuates output IY0 which also first goes logic low and then becomes 1 again. As this output is connected to the clock inputs (CLK) of the bistables, the information on the appropriate data bus line is passed on to the relevant bistable at the leading edge of the pulse on IY0. Table 1 gives the relation between the byte at the data bus (hexadecimal and decimal), the logic level at data bus lines D0 and D1, and the EPROM next in line to be enabled. The bistables ensure that the selected EPROM remains active until a fresh word is written into the EPROM address range.

Apart from the wire bridges already mentioned, six more are required as shown on the printed circuit in figure 3. Nothing further needs to be said about the construction other than that the supply voltage is derived from the computer via the ribbon cable.

It will be clear from the nature of the circuit that if, for instance, the original

EPROM is a type 2732, the additional EPROMs must be of the same type.

### Typical applications

- Loading of an extensive operating system from the EPROMs instead of floppy disk into RAM. This can be done very rapidly after which the operating system can no longer be lost accidentally. You need to write a relevant program suited to your computer, of course, and this presumes a certain familiarity with programming.
- Four banks of utility programs instead of one, or up to four programming languages may be permanently loaded onto the main store of the computer.
- change-of-character sets on a VDU card or in the character generator of a single-board computer.
- Change-over between various keyboard layouts (change-over by pressing a push-button which connects OE to earth and the simultaneous operating of a character key. The negative strobe pulse is connected to NWDS, and D0 and D1 to the relevant data lines).
- Various games may be accessed by a short instruction instead of having to load them from a cassette.

# easy music

The principle of 'Easy music' is extremely simple, as can be seen from the block diagram of figure 1. The 'musician's' whistle is picked up by a crystal microphone and amplified by op amp A1. A portion of the signal is fed to an envelope follower, which rectifies and filters it to produce a positive voltage that follows the amplitude envelope of the input signal. The signal is also fed to two limiting amplifiers, which convert the variable amplitude sinewave of the input signal into a constant amplitude squarewave having the same frequency as the input signal. This squarewave is used to clock a binary counter whose division ratio can be set to 2, 4, 8 etc., so that the output is one, two, three etc. octaves below the input signal.

The counter output is used to switch transistor T1 on and off, and the collector signal of T1 is fed to the output amplifier A4. Since the collector resistor of T1 receives its supply from the output of the envelope follower, the amplitude of the collector signal, and hence of the output signal, varies in sympathy with the amplitude of the original input signal.

The output is therefore a squarewave whose frequency may be one or more octaves lower than the input signal and

whose amplitude dynamics follow the amplitude of the input signal.

## Complete circuit

The complete circuit is given in figure 2 and the sections of the circuit shown in the block diagram are easily identified. The output of the crystal microphone is fed to P1, which functions as a sensitivity control. A1 is connected as a linear amplifier with a gain of approximately 56. A portion of the output signal from A1 is rectified by D1 and the resulting peak positive voltage is stored on C4. The output signal from A1 is further amplified by A2 and A3, the combined gain of A1 to A3 being sufficient to cause limiting at the output of A3, even with very small input signals. P2 is used to adjust the gain of the limiting amplifier so that limiting just occurs with the smallest input signal, this avoiding limiting caused by extraneous noises.

The output of A3 is used to clock a CMOS binary counter, whose division

For those who do not have the time (or perhaps the patience) to master a musical instrument, but would nonetheless like to make their own music, this simple circuit may provide the answer. The only musical accomplishment necessary is the ability to whistle in tune.

P.J. Tyrrell

ratio may be set by means of S1. The output of IC2 switches transistor T1 on and off. Since the collector resistor of T1 (R6) receives its supply voltage from C4, the amplitude of the collector signal varies in sympathy with the input signal. This signal is amplified by a small audio power amplifier built around A4, which drives a small loudspeaker.

## Additions to the basic circuit

However, the possibilities do not end there. The more ambitious constructor may wish to add filters and other circuits to produce different output waveforms which will extend the tonal possibilities of the instrument. Such variations on the basic design are, however, beyond the scope of this short article, and are left to the ingenuity of the individual reader.

Block diagram

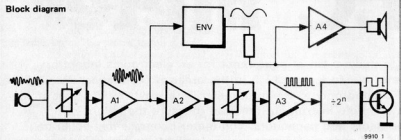

Complete circuit diagram.

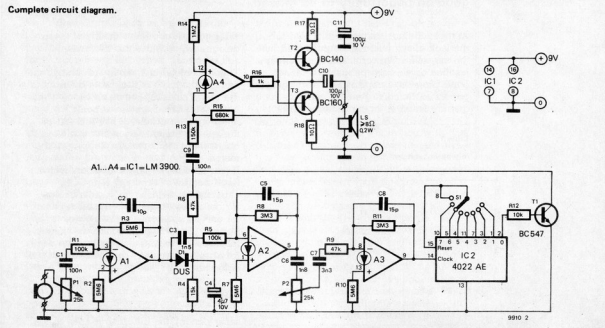

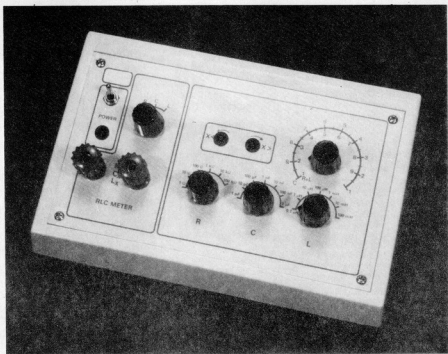

# RLC meter

to quickly  
identify  
unknown  
resistors,  
inductors and  
capacitors

If we were to make a list of equipment for an electronics laboratory this RLC meter would feature high in the order of preference. Possibly it would be second only to the multimeter. In a way this is a sort of multimeter: a simple instrument that can measure the values of resistors, inductors and capacitors. The meter is reasonably accurate, easy to build and even quite inexpensive. In short, it is simply too good an opportunity to be missed.

At times Elektor has been criticized for the lack of test instruments published in the magazine. That criticism is no longer justified as we have published (among other projects) a capacitance meter, pulse generator, function generator and frequency meter all in the last year. Con-

sidering the scope and quality of these designs we consider that no mean achievement.

This RLC meter is a worthy addition to the series although it is somewhat different to the rest. This is the inevitable result of its multimeter-like character. It could be made more specialized, like the rest of the test instrument series, but that would only serve to taint the simple form of the meter.

If you want to measure capacitors with a large degree of accuracy a good capacitance meter is the logical choice; for coils a self-inductance meter is called for and for resistors a resistance meter is in order. Should you not have the money for three test instruments or have no need for absolute accuracy then this RLC meter is the instrument for you.

## The layout

Every RLC meter follows more or less the same pattern, the differences arise in the

Table 1.  
measuring ranges

	R	L	C
1	1...10 $\Omega$	0.1...1 $\mu$ H	1...10 pF
2	10...100 $\Omega$	1...10 $\mu$ H	10...100 pF
3	100 $\Omega$ ...1 k $\Omega$	10...100 $\mu$ H	100 pF...1 nF
4	1...10 k $\Omega$	100 $\mu$ H...1 mH	1...10 nF
5	10...100 k $\Omega$	1...10 mH	10...100 nF
6	100 k $\Omega$ ...1 M $\Omega$	10...100 mH	100 nF...1 $\mu$ F
7		100 mH...1 H	1...10 $\mu$ F

way in which that design is implemented. The build-up of our RLC meter is shown in figure 1 and clearly the layout is very simple.

An oscillator feeds a specific signal to an impedance bridge. One branch of the bridge consists of the resistor, inductor or capacitor ( $Z_x$ ) that is to be measured and a reference impedance ( $Z_{ref}$ ). The other side is made up of a fixed resistor ( $R$ ) and a potentiometer ( $P$ ). The voltages at the junctions of each branch are detected and fed to a comparator that drives two LEDs. If the voltages at the junctions are different only one of the LEDs will light. When the bridge is balanced by means of the potentiometer both LEDs light. The value of the resistor, coil or capacitor under test can then be determined from the value of  $Z_{ref}$  (known) and the position of  $P$ .

The only thing that is then needed is a number of accurate switchable reference resistors, inductors and capacitors for  $Z_{ref}$  and a suitable scale for the potentiometer. This brings us to...

### The circuit diagram

The layout from the block diagram is easily recognised in the circuit diagram of figure 2. We will deal with each of the sections separately, saving the actual bridge until last as this requires the most detailed comment.

The detectors are found at the bottom of the diagram. These are IC1/D1 and IC2/D2 and the components associated with each. The inputs to the detectors (the non-inverting inputs of the op-amps) are connected to the junctions of R11/R12 and S4/R<sub>x</sub>. A close look will show that these are also the junctions of each branch of the bridge.

The output signals from the detectors are fed to op-amp IC3, which serves as a comparator. This comparator drives indicator LEDs D3 and D4 via transistors T4 and T5.

The power supply section is seen at the top right-hand corner of the diagram. This has the usual layout and requires no further comment. Just left of the power supply is the oscillator. This is based on T1, T2 and T3 and is a bit more complicated than might seem strictly necessary. The reason is that the oscillator must supply quite a lot of power in order to be able to cope with the low impedance of the loads in some of the ranges. For the same reason a (star-shaped) heatsink must be fitted to power transistor T3. The frequency of oscillation is about 18 kHz. A higher frequency would have been useful in measuring small values of inductance and capacitance but would prove an unacceptable load for the oscillator when measuring large capacitors. By the same token a lower frequency would be advantageous for measuring large inductors and capacitors but the oscillator would be as good as short circuited when measuring small inductors. The frequency of 18 kHz

1

RLC meter

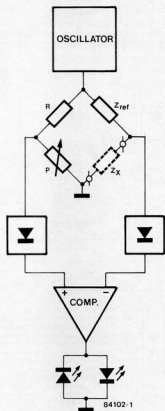

Figure 1. This block diagram shows the main parts of the RLC meter: an oscillator, a bridge network, two detectors and a comparator. The LEDs indicate when the bridge is balanced.

provides a reasonable compromise.

Now all that is left is the middle section of the diagram: the actual bridge network.

The 'fixed' branch of the bridge is seen at the left-hand side. The resistor from the block diagram,  $R$ , is formed by R10 and R11 in series, and potentiometer  $P$  is made up of R12 and P1.

In the other branch of the bridge we see two connection points for the resistor, inductor or capacitor that is to be tested ( $R_x$ ,  $L_x$ ,  $C_x$  —  $Z_x$  in figure 1). The reference impedance,  $Z_{ref}$ , is almost a separate section all of its own. We want to be able to measure resistors, coils and capacitors so we need a number of reference examples of each type of component. The number of each type needed depends on the number of ranges desired. We went the whole hog with this design by giving it seven ranges and used the most accurate components we could find. The meter will work if the reference components have a high tolerance but it will not be as accurate. The type of component to be measured,  $R$ ,  $L$  or  $C$ , is chosen with S4. The desired range can then be selected using S1, S2 or S3. The measuring range given in each case is indicated in table 1.

While we are on the subject of measuring ranges there is one point we should make. Three of the reference components, L7, C1 and R7 are marked with an asterisk in figure 2, and with good reason. The

Figure 2. The circuit diagram.

2

Parts list

Resistors:

- R1 = 10  $\Omega$ , 1%
- R2, R10, R12 = 100  $\Omega$ , 1%
- R3, R11 = 1 k, 1%
- R4 = 10 k, 1%
- R5 = 100 k, 1%
- R6 = 1 M, 1%
- R8, R18, R20 = 1 k
- R9 = 10  $\Omega$
- R13 = 10 M
- R14, R15, R17, R19 = 100 k
- R16 = 220  $\Omega$
- R21 = 1k2
- P1 = 1 k lin. pot, 5% or wirewound
- P2 = 100 k preset

Capacitors:

- C1 = \*
- C2 = 100 p, 5% (or 1%)
- C3 = 1 n, 5% (or 1%)
- C4 = 10 n, 5% (or 1%)
- C5 = 100 n, 5% (or 1%)
- C6 = 1  $\mu$ , 5% (or 1%)
- C7a, C7b = 22  $\mu$ /25 V, 5% (or 1%)
- C8 = 270 n
- C9, C17, C18, C19 = 100 n
- C10 = 470 p
- C11 = 330 p
- C12 = 470 n
- C13, C14 = 47 n
- C15, C16 = 1000  $\mu$ /16 V

Inductors:

- L1 = 1  $\mu$ H
- L2 = 10  $\mu$ H
- L3 = 100  $\mu$ H
- L4 = 1 mH
- L5 = 10 mH
- L6 = 100 mH
- L7 = 1 H\*
- L8a,b = 50 + 10 turns of 0.25 mm (SWG 33) CuL on a pot core of 18 x 11 mm (AI = 250)
- or 27 + 5 turns of 0.25 mm CuL on a twin-hole ferrite core of 14 x 14 x 8 mm (with 3.5 mm diameter holes)

Semiconductors:

- D1, D2, D9, D10 = 1N4148
- D3 = LED, green
- D4, D11 = LED, red
- D5...D8 = 1N4001
- T1 = BF256B, BF245B
- T2 = BC557B, BC559C
- T3 = BC140-16, BC141-16, 2N2219
- T4 = BC557B
- T5 = BC547B
- IC1, IC2 = CA3140
- IC3 = CA3130

Miscellaneous:

- F1 = fuse, 50 mA
- S1...S4 = single-pole 12-way rotary wafer switch
- S5 = double-pole mains switch
- T1 = mains transformer, 2 x 8 V/100 mA
- 1 off TO39 type heatsink for T3
- 4 off switch knobs with marker line (S1...S4)
- 1 off switch knob with marker needle (P1)
- 1 off case, dimensions (minimum) 190 (W) x 104 (D internal) x 62 (H rear) to 33 (H front)

\* = see text

- T1 = BF 256B; BF 245B
- T2 = BC 557B; BC 559C
- T3 = BC 140-16; BC 141-16; 2N2219

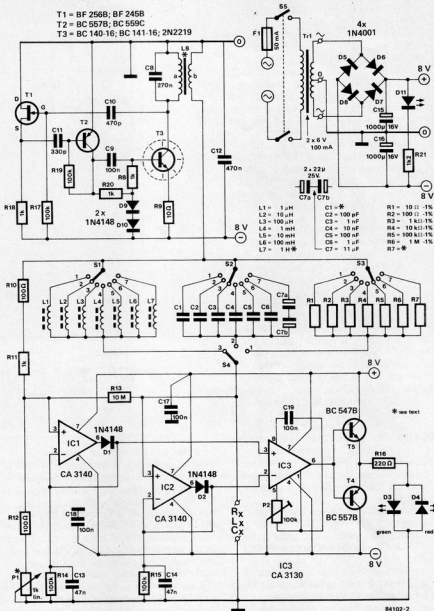

largest value inductor, L7, may not be available as a close-tolerance item but that is not necessarily a problem. Using a higher-tolerance part will simply make this range less accurate.

The difficulty with C1 and R7 is quite different. In both of these ranges the capacitance and resistance of the tracks on the printed circuit board have quite a large effect. The problem can be solved for C1 by using a trimmer here and adjusting this to give exactly the value of capacitance needed between the common pole of S2 and contact number 2 of S4. (We will return to this point at the end of this article.) The largest value resistor, R7, is not available at 1% with a value of 10 M $\Omega$  so it will have to be omitted from

the parts list, leaving us with an upper measuring range extending up to 1 M $\Omega$ .

Construction

With the exception of the parts already mentioned the components for the RLC meter should not be a problem. One of the inductors, L8, will have to be wound. Details are given in the parts list. The printed circuit board used for this RLC meter is shown in figure 3. All components except the mains transformer and power switch can be fitted directly onto the board. The photograph in figure 4 shows what the finished board looks like. The meter can be mounted in any sort of

case you like but it is only logical to fit the printed circuit board directly behind, (or under) the front panel. Five points on the copper side of the board in the middle of each of S1...S4 and P1 indicate the centre of the switches and potentiometer. In this way the board can be

considered as a template for the front panel. Provision must be made for fitting the LEDs, power switch and input sockets, of course, but their positions are not really critical. To fit into the case we used for the meter the corners of the printed circuit board had to be filed off. The mains

RLC meter

Figure 3. Almost all the components for the RLC meter are mounted on this printed circuit board. The board is also used as a template for drilling holes in the front panel.

3

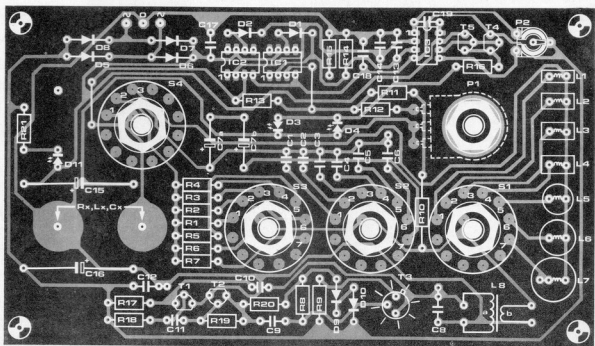
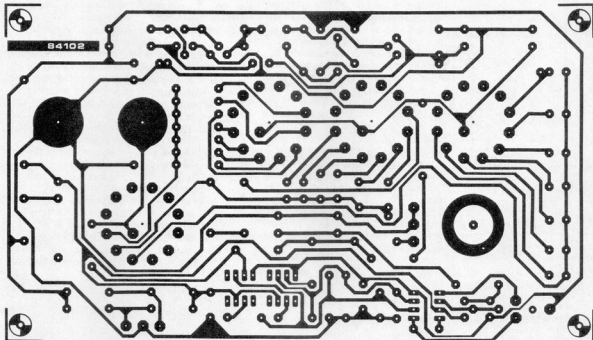

transformer was fixed to the back panel. There are a few other small, but important, points regarding construction:

- Some of the components, such as L6, L7 and L8, may appear too high to fit between printed circuit board and front panel. If this is the case the components in question can be mounted on the reverse side of the board.
- There are two methods of connecting the rotary switches and the potentiometer to the board. The soldering lugs can be soldered directly to the board and this will also help to keep it solidly in position. Alternatively, mount the switches and pot onto the front panel and use wires to make the necessary connections.
- Keep all the wiring, especially from the input sockets, as short as possible. If the input sockets tend to foul the board a couple of holes can be drilled in the board through which the sockets can protrude.
- The mains switch mounts directly onto the front panel. Above LED D11 on the printed circuit board there is a small hole. The mains wires to the switch pass through this hole.
- There is also a hole drilled under P2 on the board. This is used to trim the preset after the board has been assembled.

## Using the meter

Before the meter can be used the rotary switches and the potentiometer must be provided with suitable scales. For this we refer you to figure 5, which shows one possible front panel layout. A double scale is needed for P1 as the graduations for capacitors run in the opposite direction to those for resistors or coils. The graduations for P1 are linear for almost all ranges, only deviating in some of the upper ranges. We will return to this point in the section on calibration.

Using the RLC meter is very easy:

- Connect the component to be measured to the input sockets, keeping the wires or leads as short as possible.
- It is reasonable to assume that the type of component to be tested is known so the appropriate position of S4 (R, L or C) can be chosen.
- Generally you will have some idea of the value of the component so the appropriate range is selected with the relevant switch, S1, S2 or S3.
- Potentiometer P1 is then turned until both LEDs (D3 and D4) light.
- If that does not happen the range is incorrect so other ranges will have to be tried until the one is found in which the two LEDs do light when P1 is turned.
- With both LEDs lit simply read off the value that P1 is pointing to and multiply

Figure 4. This photograph shows clearly how all the various components fit onto the printed circuit board.

4

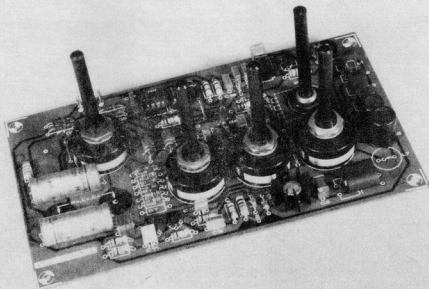



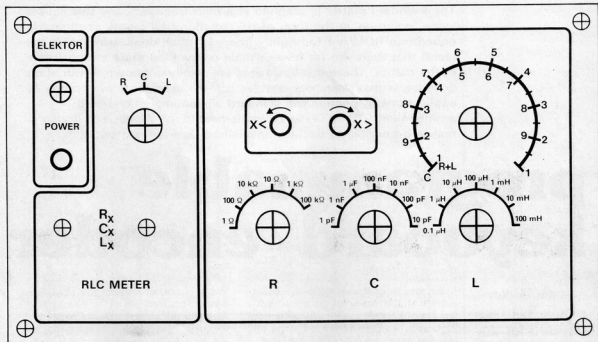

84102-5

it by the range selected. The result is the value of the component that was measured.

### Calibration

Calibrating the circuit is a matter of adjusting out the offset of IC3, which is very simple. Short pins 2 and 3 of IC3 together and trim preset P2 until LEDs D3 and D4 are both off.

Before starting on the actual scale calibration procedure there is something we would like to point out. If the most accurate of reference components (R1...R6, L1...L7, C1...C7) are used an accuracy of 1% can be achieved. Calibration must then also be carried out with 1% components. If standard components (5% tolerance) are used for calibration the meter will be less accurate but this should still be sufficient for most purposes.

In the 'normal' ranges (it will soon become clear which they are) there is no real need for calibration and the scale indicated in figure 5 can be used. To verify this scale for each range a component whose value is known can be connected to the input sockets and when P1 is adjusted so that both test LEDs are lit the pointer should indicate the right value. Three ranges could be considered as 'problematic', namely range 6 resistors (100 k...1 M), range 1 capacitors (1...10 p)

and range 1 inductors (0.1...1 μH). If these ranges are not to be used then there is no problem. If they are wanted, however, a separate scale will have to be made for each range as the graduations are no longer linear. In resistor range 6 an 'infinite' resistance is indicated not at the end of the scale but rather at about 3/4 of full scale. The same applies for the '0' in capacitor range 1, while the '0' in inductor range 1 corresponds to about 1/4 way from the start rather than the expected position. A large number of components within these ranges will be needed to work out the graduations for P1's scale. Place each value of component in the test (input) sockets in turn and mark the corresponding position on the scale. In this way the three scales can be made.

We have already mentioned that there could be a problem with C1. Stray or parasitic capacitance caused by the actual printed circuit board tracks can cause the value to deviate from the anticipated 10 p. The way around this problem is to use a fixed capacitor of 6.8 p with a 3 p trimmer in parallel with it. Connect an accurate 10 p calibration capacitor to the input sockets and adjust the trimmer until the 10 p corresponds exactly to the start (left-most position) of the scale of P1. ■

Figure 5. Here we see one possible layout for the meter's front panel. The text of the article provides some information about the scale used for potentiometer P1.

The large scale integration (LSI) alphanumeric keyboard encoder ICs are now quite well known, so much so, in fact, that they have become almost classical. Their good features have been loudly heralded but they also have a number of unfavourable characteristics. The keyboard matrix is scanned at a high frequency and this causes some 'pollution' in the form of HF radiation; the matrix configuration coded into ROM is fixed rigidly; there is much duplication, with the result that there are far fewer usable codes than there are positions in the matrix. These disadvantages are totally unknown to our static encoder, whose versatility enables it to be used for a wide range of applications. It permits the standard alphanumeric keyboard arrangement (QWERTY) to be implemented, of course, but it also makes it possible to use any specialised user-defined layout.

# programmable keyboard encoder

a static 80-key  
matrix that can  
be used for any  
application

A discrete programmable encoder could provide an alternative for the encoder ICs that are commonly used in alphanumeric keyboards. An EPROM is used in the section that generates the output codes so every imaginable configuration is both feasible and easily realised. There is no duplication in the matrix except that a key may be used more than once. In general this only applies to the keys for SHIFT, CTRL, and numbers 0...9 and letters A...F, which are often found on a hexadecimal keyboard as well as the main one. The effect of the SHIFT and CTRL keys on the hexadecimal keypad, which could cause problems, can easily be neutralised.

## Simultaneous high and low logic levels

One of the most striking aspects of the circuit diagram of figure 1 is the presence of CMOS ICs and an auxiliary voltage of 18 V among the TTL circuits. This mixture allows the logic level on the matrix columns to be different from that on the rows, although both are based on the same voltage.

There is no keyboard scanning in the normal sense of the expression. The 80-key matrix is located between two priority encoders, one being a CMOS 8-bit device (IC5), the other a 10-bit TTL chip (IC6). Strobe pulses (STROBE and  $\overline{\text{STROBE}}$ ) are generated by gates N1, N2, N3 and N5, which activate IC3 so that it stores the data output by the EPROM. There is a special facility in the circuit, provided by gates N4, N6, N7 and N8, to enable the keyboard to be addressed directly on the computer's data bus without first having to pass through a peripheral IC such as a VIA or PIO.

All the columns in the matrix are forced

low by means of resistors R1...R8. When a key is pressed one of the columns goes high and the binary code corresponding to one of lines X0...X7 then appears on the A0...A2 outputs of encoder IC5. Row lines Y0...Y9, on the other hand, are forced high by resistors R9...R18 in the rest state. As soon as a key is pressed the relevant line goes low. The appropriate binary code then appears (inverted) at the output of 10-bit priority encoder IC6.

It may seem a bit strange to note that in this circuit the same voltage is a logic low level for one line and a high level for another line. This arises from the fact that when a key is pressed the voltage at the appropriate column/row intersection is about 4 V. This is a 'high' for IC5, which has a 5 V supply, but a 'low' for IC7 (or IC8), whose logic levels are determined with respect to the 18 V on pin 16. The output logic levels for IC7 and IC8 are fixed with respect to the voltage at pin 1, which is 5 V here in order to ensure compatibility with the TTL ICs. Note in passing that input 0 of IC6 is not used although this chip does encode 10 lines. The tenth matrix line (Y0) is not connected to the 74LS147. When none of the other nine lines is active the output of IC6 is '1111' (the inverse of '0000'), which corresponds to the binary code for line Y0. You may wonder what would happen to these voltages if several keys were pressed at the same time, particularly if they are in the same column. The greater the number of 33 k resistors in parallel on the same column the higher the voltage input to IC5. For this reason each of the columns is fitted with a protection diode (D1...D8) to limit the voltage to 5.6 V. Consequently the danger of destroying IC5 is removed. Furthermore the code output from the encoders if several keys are pressed at the same time is always that for

from an idea  
by C. Bajoux

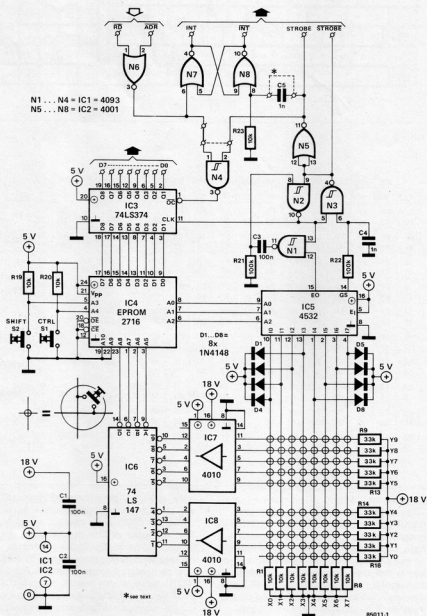

the key at the highest co-ordinates of the X/Y matrix.

### The code conversions

The ASCII codes corresponding to every position in the matrix are stored in a 2716 EPROM (IC4). As could be expected, the two priority encoders provide a binary code that is used to address the EPROM. There are four codes corresponding to

each key: the key itself, the key with SHIFT pressed, the key with CTRL and the key with both SHIFT and CTRL pressed. The latter two keys are connected to A3 and A4 respectively, and as they can be pressed individually or simultaneously this is an easy way of increasing the number of codes that can be accessed. We will see shortly how the contents of the EPROM is arranged but first we must have a look at the upper part of figure 1.

Figure 1. This programmable keyboard encoder can be accessed directly from a microprocessor's data bus. If this facility is not used the wire bridge linking pin 1 of N4 and pin 3 of N6 must be removed and replaced by a link connecting both inputs of N4 to the output of N5.

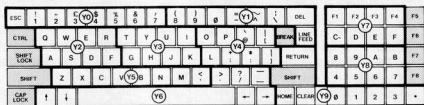

Figure 2. This diagram shows how the keys in a normal 'alphanumeric plus hexpad' keyboard are arranged in the matrix rows. Other layouts are, of course, possible.

Table 1.

function	X0		X1		X2		X3		X4		X5		X6		X7		X8		X9		X10		X11		X12		X13		X14		X15		X16		X17		col.		line			
	0	1	2	3	4	5	6	7	8	9	A	B	C	D	E	F	G	H	I	J	K	L	M	N	O	P	Q	R	S	T	U	V	W	X	Y	Z						
C + S	0C	FF	FF	FF	FF	FF	FF	FF	FF	FF	FF	FF	FF	0D	1C	0C	30	31	32	33	2E	Y9	C	N																		
S	0D	0D	1C	01	30	31	32	33	2E	08	1C	0C	30	31	32	33	33	37																								
C + S	0E	FF	FF	FF	FF	FF	FF	FF	FF	FF	FF	FF	FF	38	39	41	42	34	35	36	37	Y8	C	N																		
S	0F	38	39	41	42	34	35	36	37	38	39	41	42	34	35	36	37																									
C + S	10	FF	FF	FF	FF	FF	FF	FF	FF	FF	FF	FF	FF	FF	FF	FF	FF	FF	FF	FF	FF	Y7	C	N																		
S	11	FF	FF	FF	FF	FF	FF	FF	FF	FF	FF	FF	FF	FF	FF	FF	FF	FF	FF	FF	FF																					
C + S	12	FF	FF	FF	FF	FF	FF	FF	FF	FF	FF	FF	FF	0B	0A	20	00	00	1F	08	09	Y6	C	N																		
S	13	0B	0A	20	3E	3F	5F	08	09	0B	0A	20	2E	2F	5F	08	09	08	0A	0B																						
C + S	14	FF	FF	FF	FF	FF	FF	FF	FF	FF	FF	FF	FF	1A	18	03	16	02	0E	0D	00	Y5	C	N																		
S	15	5A	58	43	56	42	4E	4D	3C	7A	78	63	76	62	6E	6D	2C																									
C + S	16	FF	FF	FF	FF	FF	FF	FF	FF	FF	FF	FF	FF	0F	10	00	1B	0C	00	00	1D	Y4	C	N																		
S	17	4F	50	60	78	4C	2B	2A	5D	6F	70	40	58	6C	3B	3A	7D																									
C + S	18	FF	FF	FF	FF	FF	FF	FF	FF	FF	FF	FF	FF	14	19	15	09	07	08	0A	0B	Y3	C	N																		
S	19	54	59	55	49	47	48	4A	4B	74	79	75	69	67	68	6A	6B																									
C + S	1A	FF	FF	FF	FF	FF	FF	FF	FF	FF	FF	FF	FF	11	17	05	12	01	13	04	06	Y2	C	N																		
S	1B	51	57	45	52	41	53	44	46	71	77	65	72	61	73	64	66																									
C + S	1C	FF	FF	FF	FF	FF	FF	FF	FF	FF	FF	FF	FF	00	00	00	1E	1C	7F	0A	Y1	C	N																			
S	1D	28	29	00	3D	7E	7C	7F	0A	38	39	30	2D	5E	5C	7F	0A																									
C + S	1E	FF	FF	FF	FF	FF	FF	FF	FF	FF	FF	FF	FF	1B	00	00	00	00	00	00	00	Y0	C	N																		
S	1F	1B	21	22	23	24	25	26	27	1B	31	32	33	34	35	36	37																									

Table 1. Using an EPROM to aid addressing the matrix positions ensures that there is no duplication, no 'holes' and no incongruities. Four different codes can be attributed to each of the keyboard's 80 keys.

The data output from IC4 is latched into IC3, whose outputs can be connected directly to a data bus. (When the 74LS374 is not enabled its Q1...Q8 outputs have a high impedance.) This latching is essential as the data must remain stable when the key is released. Information is input to IC3 from its D1...D8 lines when the CLK input detects a falling edge — provided in this case by IC5's enable output (EO) via debounce network N1...N3. As long as no key is pressed pin 15 of IC5 is high and pin 14 (GS) is low. Pressing a key causes these signals to invert (but with overshoot); they return to the quiescent state as soon as the key is released. The EO and GS (group select) outputs are used as the basis for the STROBE and STROBE pulses and also for the pulse used to clock eight-bit latch IC3. The STROBE signal is also fed via N4 to enable the addressing of IC3.

The keyboard can, as we have already said, be accessed directly by a microprocessor's data bus. This is only possible during the strobe pulse, which allows N4 to pass on the addressing signal provided by N6. The output of this latter gate can

only be high if both the read signal (RD) and the address decoding signal (ADR) are active ('0' in each case).

The keyboard can be programmed for polling mode, in which the processor itself examines the state of the STROBE line, or interrupt mode, whereby flip-flop N7/N8 supplies the interrupt signal (INT or INT) when a key is pressed. If capacitor C5 is replaced by a wire bridge flip-flop N7/N8 is only initialised when the processor addresses the keyboard. In fact the flip-flop is initialised only when the key is released so this makes it easy to implement a repetition function controlled by the software. If, on the other hand, C5 is included in the circuit the flip-flop is initialised as soon as the RD and ADR signals become active.

### Programming the EPROM

Each key has four corresponding addresses in the EPROM: first is the key together with both SHIFT and CTRL, then the key with CTRL only, followed by the key with SHIFT only and finally the single key on its own. It is also conceivable to

Table 2.

programmable  
keyboard encoder

C = CONTROL (S1); S = SHIFT (S2); N = NORMAL

	X0	X1	X2	X3	X4	X5	X6	X7	
Y9	CR	FS	FF	0	1	2	3	.	C
	CR	FS	FF	0	1	2	3	.	S
	CR	FS	FF	0	1	2	3	.	N
Y8	8	9	A	B	4	5	6	7	C
	8	9	A	B	4	5	6	7	S
	8	9	A	B	4	5	6	7	N
Y7	F1	F2	F3	F4	C	D	E	F	C
	...	...	...	...	C	D	E	F	S
	...	...	...	...	C	D	E	F	N
Y6	VT	LF	SP	NUL	NUL	US	BS	HT	C
	VT	LF	SP	>	?	-	BS	HT	S
	VT	LF	SP	.	/	-	BS	HT	N
Y5	SUB	CAN	ETC	SYN	STX	SO	CR	NUL	C
	Z	X	C	V	B	N	M	<	S
	z	x	c	v	b	n	m	.	N
Y4	SI	DLE	NUL	ESC	FF	NUL	NUL	GS	C
	O	P	.	{	L	+	*	}	S
	o	p	@		l	;	:		N
Y3	DC4	EM	NAK	HT	BEL	BS	LF	VT	C
	T	Y	U	I	G	H	J	K	S
	t	y	u	i	g	h	j	k	N
Y2	DC1	ETB	ENQ	DC2	SOH	DC3	EOT	ACK	C
	Q	W	E	R	A	S	D	F	S
	q	w	e	r	a	s	d	f	N
Y1	NUL	NUL	NUL	NUL	RS	FS	DEL	LF	C
	(	)	NUL	=	~		DEL	LF	S
	B	9	0	-	^	\	DEL	LF	N
Y0	ESC	NUL	NUL	NUL	NUL	NUL	NUL	NUL	C
	ESC	!	"	#	\$	%	&	'	S
	ESC	1	2	3	4	5	6	7	N
Y0...									
Y9	...	...	...	...	...	...	...	...	S + C

have several blocks of different codes whereby the block selected depends on the logic levels applied to lines A9 and A10 of the EPROM. In our circuit diagram this possibility is not used so these two address lines are kept low. When programming the EPROM it is essential to bear in mind that the outputs of IC6 are inverted. The lowest accessible address (0C0HEX) corresponds to key X0Y9 when S1 and S2 are closed. The highest address is 1FFHEX, which corresponds to key X7Y0 with S1 and S2 both open. Starting with the lowest address the first codes programmed correspond to row Y9 (moving from left to right) with S1 and S2 closed. These are followed by the same keys but this time with S1 closed and S2 open, then the same again except that S1 is open and S2 is closed, and finally the same row with both S1 and S2 open. The second row, Y8, starts at address 0E0HEX with the leftmost key, S1 and S2 being closed. The same sequence is then followed as for row Y9.

This procedure was used to formulate table 1 for an alphanumeric keyboard such as that shown in figure 2. The layout

is in no way unusual as it is only intended as an example. Note that the keys of the hexadecimal keypad are not effected by the positions of SHIFT or CTRL. The lower part of this table is open as we have only dealt with the 'normal' use of the keys. If an application requires extra codes to be generated this can easily be done by programming an additional code for each of the 80 keys. The appropriate code will then be output when any key is pressed by the same time as both SHIFT and CTRL. These codes will then be substituted for the FFs in table 1 at addresses 0C0...0C7, 0E0...0E7, 100...107, 120...127 and so on up to 1E0...1E7. ■

Table 2. It is clear from table that the CTRL and SHIFT keys do not effect the hexadecimal keys on the separate keypad. No codes have been included in this table to cater for special functions generated by pressing a key at the same time as both SHIFT and CTRL.

## digital graphic equalizer

Among the many new ICs from National Semiconductor is one that combines microprocessor and audio techniques. This is the LMC 835: a monolithic digitally controlled graphic equalizer IC, which is manufactured in LSI (large-scale integration) CMOS technology and is intended for use in high performance audio applications. Basically, the LMC 835 consists of a logic section and a signal-path section made up of analogue switches and thin-film silicon-chromium resistor networks. Used with external resonator circuits, the IC makes a stereo equalizer with seven bands, each with a  $\pm 12$  dB or a  $\pm 6$  dB gain range in twenty-four steps. A block diagram of the interior of the LMC 835 is shown in figure 1.

The control function is carried out by three digital input signals: the clock, a strobe, and a serial data control word. The control data is divided into the band selection data, referred to as DATA I, and the gain selection data, DATA II. These data sets may be provided by a microprocessor and are entered in serial format in conjunction with the strobe as illustrated by the waveform timing diagram in figure 2.

The truth tables for the data sets are shown in figure 3. It will be seen that bit D7 of the data word determines a band selection or a gain selection; it is high for DATA I and low for DATA II. Bit D6 is used only during the gain selection (DATA II) to effect either a boost or a cut in the gain response. Bits D4 and D5 in the DATA I band selection table determine the gain selection response characteristics.

The audio signal path of the LMC 835 is designed for very low noise and distortion to result in very high performance compatible with PCM (pulse code modulation) audio applications. As well as a graphic equalizer, the LMC 835 can be used for many other applications, including volume control with very low total harmonic distortion, a mixer, tape equalization, and special-effect circuits for musical instruments.

The circuit diagram in figure 4 shows a seven-band stereo equalizer. It includes another new IC from National Semiconductor: the LM 833 dual low-noise opamp. Z1...Z7 are tuned circuits, details of each of which are shown in figure 5 together with a table for the individual components for each band.

The LMC 835 uses CMOS analogue switches that have very small leakage currents: less than 50 nA. When a

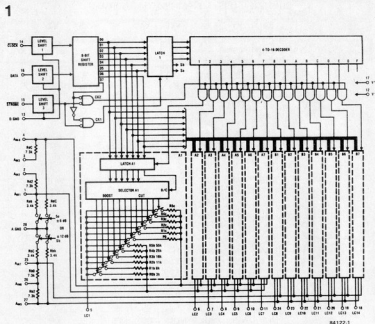

Figure 1. As shown in the block diagram, the LMC 835 contains a digital control section and an analogue section consisting of 14 analogue switches.

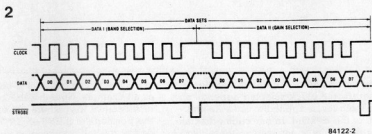

Figure 2. The timing diagram of the digital control inputs of the LMC 835.

3

		DATA II (Gain Selection)								
		D7	D6	D5	D4	D3	D2	D1	D0	
Flat	1 dB Boost	L	X	L	L	L	L	L	L	
	2 dB Boost	L	H	H	L	L	L	L	L	
	3 dB Boost	L	H	L	H	L	L	L	L	
	4 dB Boost	L	H	L	L	H	L	L	L	
	5 dB Boost	L	H	L	L	L	H	L	L	
	6 dB Boost	L	H	L	H	L	L	H	L	
	7 dB Boost	L	H	H	L	H	L	H	L	
	8 dB Boost	L	H	L	L	L	L	L	H	
	9 dB Boost	L	H	L	L	L	L	L	H	
	10 dB Boost	L	H	H	L	H	L	H	H	
	11 dB Boost	L	H	L	H	L	H	H	L	
	12 dB Boost	L	H	L	H	L	H	H	H	
1 dB ~ 12 dB Cut	L	L								
		Valid Above Input								
		↑	↑	← Gain Code →						
		1	2							

This is the gain if the  $\pm 12$  dB range is selected by DATA I. If the  $\pm 6$  dB range is selected, then the values shown must be approximately halved.

1 DATA II  
2 Boost/Cut

Figure 3. The control data truth tables. The data may be provided by a microprocessor.

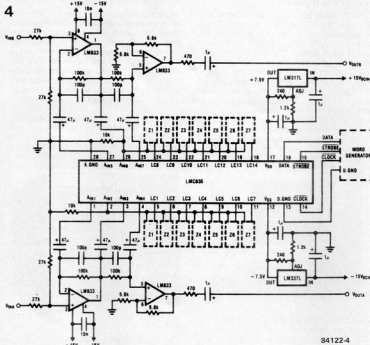
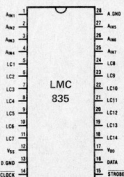

Figure 4. The circuit diagram of a 7-band stereo equalizer using the LMC 835.

### Electrical characteristics

supply voltage	5...16 V
supply current	5 mA maximum
clock frequency	2 MHz (typical)
minimum data set-up time	1 μs
minimum data hold time	1 μs
input current	1 μA maximum
gain error	0.5 dB maximum
total harmonic distortion	0.1% maximum (at 1 kHz)
maximum output voltage signal to noise ratio	5 V r.m.s. (minimum)
	106 dB (typical)

### Dual-In-Line Package



Top View 84122

DATA I (Band Selection)							
D7	D6	D5	D4	D3	D2	D1	D0
H	X	L	L	L	L	L	L
H	X	L	L	L	L	L	H
H	X	L	L	L	L	L	H
H	X	L	L	L	L	H	H
H	X	L	L	L	H	L	H
H	X	L	L	L	H	L	H
H	X	L	L	L	H	L	H
H	X	L	L	L	H	H	H
H	X	L	L	H	L	L	L
H	X	L	L	H	L	L	H
H	X	L	L	H	L	H	L
H	X	L	L	H	L	H	L
H	X	L	L	H	L	H	H
H	X	L	L	H	H	H	H
H	X	L	L	H	H	H	H
H	X	H	L				Valid Binary Input
H	X	H	L				Valid Binary Input
H	X	H	H				Valid Binary Input
↑	↑	↑	↑				Band Code →
1	2	3	4				

- DATA 1
- Don't Care
- Ch A ± 6 dB / ± 12 dB Range
- Ch B ± 6 dB / ± 12 dB Range

(Ch A: Band 1-7, Ch B: Band 8-14)

- Ch A ± 12 dB Range, Ch B ± 12 dB Range, No Band Selection
- Ch A ± 12 dB Range, Ch B ± 12 dB Range, Band 1
- Ch A ± 12 dB Range, Ch B ± 12 dB Range, Band 2
- Ch A ± 12 dB Range, Ch B ± 12 dB Range, Band 3
- Ch A ± 12 dB Range, Ch B ± 12 dB Range, Band 4
- Ch A ± 12 dB Range, Ch B ± 12 dB Range, Band 5
- Ch A ± 12 dB Range, Ch B ± 12 dB Range, Band 6
- Ch A ± 12 dB Range, Ch B ± 12 dB Range, Band 7
- Ch A ± 12 dB Range, Ch B ± 12 dB Range, Band 8
- Ch A ± 12 dB Range, Ch B ± 12 dB Range, Band 9
- Ch A ± 12 dB Range, Ch B ± 12 dB Range, Band 10
- Ch A ± 12 dB Range, Ch B ± 12 dB Range, Band 11
- Ch A ± 12 dB Range, Ch B ± 12 dB Range, Band 12
- Ch A ± 12 dB Range, Ch B ± 12 dB Range, Band 13
- Ch A ± 12 dB Range, Ch B ± 12 dB Range, Band 14
- Ch A ± 12 dB Range, Ch B ± 12 dB Range, No Band Selection
- Ch A ± 6 dB Range, Ch B ± 6 dB Range, Band 1-14
- Ch A ± 6 dB Range, Ch B ± 12 dB Range, Band 1-14
- Ch A ± 6 dB Range, Ch B ± 6 dB Range, Band 1-14

band is selected for flat gain, all the switches in that band are open and the resonator circuit is not connected to the LMC 835 resistor network. It is only in the flat mode that the small leakage current can cause problems. The input to the resonator is a capacitor which will be charged slowly by the leakage current to a high voltage if there is no limiting resistor. When the band is set to a characteristic other than flat, the charge on the capacitor will leak away via the resistor network and cause a transient at the output. This will manifest itself as switching noise when the gain is changed.

To prevent switching noise arising from leakage currents, it is necessary to include a resistor  $R_{LEAK}$  of 100 k between pin 2 and each of pins 5...11 and between pin 26 and each of pins 18...24. This resistor, as shown in figure 5, limits the voltage the capacitor can charge to with minimum disturbance to the equalization. The consequent gain error is only 0.2 dB, while the resulting Q error is about 5 per cent at 12 dB cut or boost.

The LMC 835 is expected to become available early this year.

$Q_D = 3.5, Q_{12dB} = 1.05$				
Z1	$f_D$ (Hz)	$C_D$ (F)	$C_1$ (F)	$R_0$ (Ω)
21	63	1 μ	0.1 μ	100k
22	160	0.47 μ	0.033 μ	100k
23	400	0.15 μ	0.015 μ	100k
24	1k	0.068 μ	0.0068 μ	82k
25	2.5k	0.022 μ	0.0023 μ	82k
26	6.3k	0.01 μ	0.0015 μ	62k
27	16k	0.0047 μ	680p	47k

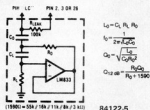

84122-5

Figure 5. The circuit diagram and component values for the individual band resonators.

## MI THERMOCOUPLES

The MI thermocouples offered by Point Electronics consist of a metal sheath having the thermoelectric conductors embedded with magnesium oxide insulation. This construction is self armoured and protects against oxidation or environmental contamination during service. These thermocouples are small in diameter, flexible and are impervious to water, gas and oil.

Types K and J are available in diameters varying from 1 mm to 4.5 mm. Amultiple choice of hot and cold end terminations are available.

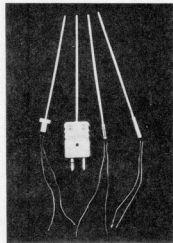

For further information, write to:  
Point Electronics Pvt. Ltd.,  
1023/1024, IV Block,  
Rajaji Nagar, Bangalore 560 010.

## TV COMPONENTS

Atron Electronics Industries have introduced Linearity Coils and Line Driver Transformers for 12, 14, and 20 inch TV sets—Black and White as well as Colour.

The Atron range also covers TV components like SMPS Transformers, Noise Suppression Filters, Balun Transformers, Degaussing Coils etc. The quality and reliability is claimed to be very high.



For further information, write to:  
Atron Electronic Industries  
62—A, Mahatma Gandhi Road,  
Secunderabad 500 003.

## COMPUTERSCOPE

The Computerscope—Ind. from RC Electronics U.S.A. is a powerful tool designed for capturing transient signals, with high speed and high resolution. The unit is very flexible and it can operate as Digital Storage Oscilloscope, Digital Voltmeter, Spectrum Analyser, Chart Recorder, Signal averager, Histogram Analyser, Frequency Meter, Multiple Sweep 3—D Display and Waveform Analyser. The acquired data is stored on disc and can be displayed conveniently at any time for analysis and comparison. A wide range of hardware/software options are available.



For further information, write to:  
Datacon Systems  
7/8, Vir Bharat, Timber Market,  
Pune 411 042.

## CONTROL TRANSFORMERS

Shepherd Transformers introduce a complete range of control transformers in single and three phase versions.

These transformers find a wide variety of applications in control panels, electrical and electronic equipments, electromechanical machinery, cranes, elevators, material handling equipment etc.

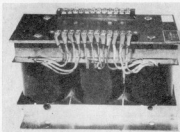

For further information, write to:  
Shepherd Transformers  
Shed No. 4, Vallabh Society,  
90 feet Road, Ghatkopar (East),  
Bombay 400 075.

## POWER INVERTERS

Jayant Electric and Radio corporation offers power inverters with capacities from 200 VA to 5 KVA. These inverters are useful for operation of lights, musical instruments, audio and video equipment from car batteries. The DC input can be from 12 to 48 volts depending on the model and the output is  $230 V \pm 5\%$  sine or square wave at  $50 Hz \pm 1\%$ . The circuit is fully solid state and meets requirements of JSS (Mil. Std.) Efficiencies are claimed to be better than 80% for square wave and 60% for sine wave. The construction is rugged and can withstand vibrations in mobile vehicles even on rough roads.

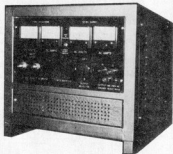

For further information, write to:  
Jayant Electric and Radio Corporation,  
5B, Naigaum Cross Road,  
Wadala, Bombay 400 031.

## TEMPERATURE INDICATOR

Protek's new Digital Temperature Indicator uses 25 mm high LEDs for the digital display for extending the viewing range. Measurement ranges available are from  $-200^{\circ}C$  to  $+1200^{\circ}C$ , with suitable sensors. Automatic ambient temperature compensation and sensor break indication are incorporated in the circuit. The reading stability is claimed to be high due to signal being routed through amplifier stages. The instrument is available in standard DIN size and operates directly on mains.

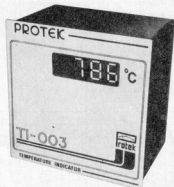

For further information, write to:  
PROTEK  
88/3 Parvati,  
Chintamaninagar,  
Pune 411 009.



## MEMBRANE KEY BOARD

Electronumerics have announced a new Membrane Key Board. The Membrane Key Board is suitable for various instruments and office equipments. It can be supplied as standard ASCII encoded key board or as custom made keyboard complete with attractive graphics as per requirement.

For Further information, write to:

Electronumerics  
Kammagondanahalli,  
Opp. HMT Industrial Estate,  
Jalahalli (West)  
Bangalore-560 015.

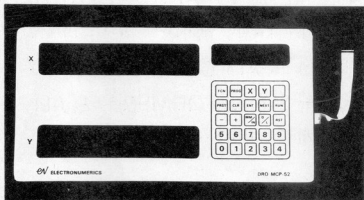

For Further information, write to:

Elmatronic Devices  
14 Hanuman Terrace,  
2nd Floor, Lamington Road,  
Bombay 400 007.

## INTERCOM SYSTEM

CONTACT is the new Intercom System introduced by Micro Systems. The Intercom System covers a wide range from 2 lines to 60 lines. It has all the standard features such as—LED indicators, complete privacy, conference facility etc. Voice fidelity is claimed to be exceptionally high. Enclosure is of moulded ABS and is available in attractive colours.



For further information, write to:

Micro Systems  
Nilesh Apartments,  
268 Shaniwar Peth,  
Pune 411 030

## CLAP LITE

Barathronics introduce a new clap controlled bed-light which can be put ON/OFF by just a single clap of hands. The lamp operates directly on mains supply and is sensitive to clapping of hands or any similar sound. Range of operation is about 10 feet. Lamp used is 6.3 Volts 115 mA bulb, consuming approximately 0.6 Watts power.

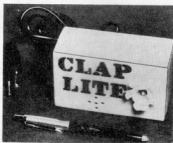

For further information, write to:

Barathronics  
53, Temple Street,  
Malleswaram  
Bangalore 560 003

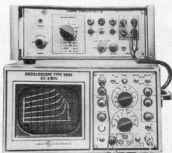

For further information, write to:

Vasavi Electronics  
630, Alkarim Trade Centre  
Ranigunj, Secunderabad 500 003

## POWER OP AMP

PA 01 is a high voltage, high output current operational amplifier designed to drive resistive inductive and capacitive loads. It has a complimentary darlington emitter follower output stage protected against inductive kick-back or back EMF. The Op Amp is available in 8 pin TO-3 package which is hermetically sealed by one shot resistance welding. The PA 01 is claimed to be suitable for majority of applications in which the uA 791 Op Amp is used.



## ADIVISON

Advision is a product based on video technology for display of information on a TV screen. It is a compact, stand alone unit with pre programmed memory cartridge. The display scrolls continuously at preset speed. New message can be entered by replacing the cartridge. Typewriter styled keyboard is also provided for instant data entry. Data can be edited using the same keyboard before entering it into memory.

Advision is useful in Banks, Theatres, Show Rooms, Hotels, Hospitals, Exhibitions, Railway Stations, Airports etc.



For further information, write to:

Intek Engineers  
7/8 Vir Bharat,  
New Timber Market,  
Pune 411 002

## CURVE TRACER

Vasavi Electronics have developed an easy to use versatile curve tracer VCT 12, which can display voltage/current characteristics of electronic devices like transistors, diodes, FETs, etc. Necessary voltages are provided in the instrument for studying the transfer characteristics of FETs and triodes. External oscilloscope having DC coupling on X and Y system is essential for VCT 12 to display the characteristics.

Luxco car stereo speakers bring concert hall performance to you —crystal clear Hi—Fi stereo, well above the wind and traffic noise.

**Make driving  
a pleasure  
with**

**LUXCO** car stereo speakers

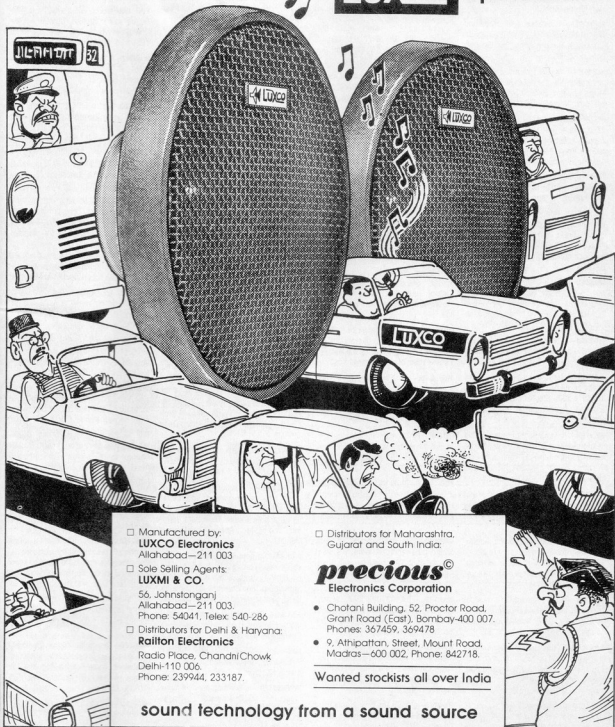

Manufactured by:  
**LUXCO Electronics**  
Allahabad—211 003

Sole Selling Agents:  
**LUXMI & CO.**  
56, Johnstonganj  
Allahabad—211 003  
Phone: 54041, Telex: 540-286

Distributors for Delhi & Haryana:  
**Railton Electronics**  
Radio Place, Chandni Chowk  
Delhi-110 006.  
Phone: 239944, 233187.

Distributors for Maharashtra,  
Gujarat and South India:

**precious**<sup>®</sup>  
Electronics Corporation

- Chotani Building, 52, Proctor Road,  
Grant Road (East), Bombay-400 007.  
Phones: 367459, 369478
- 9, Athipattan, Street, Mount Road,  
Madras—600 002, Phone: 842718.

**Wanted stockists all over India**

**sound technology from a sound source**

# Why use just any Micro $\Omega$ meter when there are 2 great ones around?

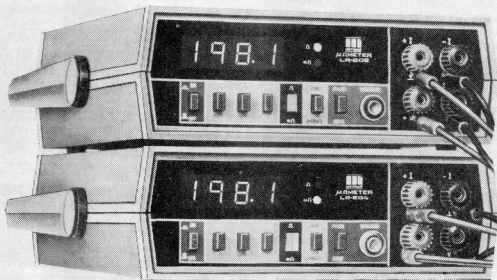

The Motwane 3 1/2 Digit LR-204 and 205, developed in our inhouse R & D Laboratory are Exceptional instruments. To begin with, they're a digital series enjoying their inherent advantages at analog prices. Cost/performance bargains in Micro-ohmmeters, because of their excellent accuracy, high reliability and effortless operation.

The LR series read in 6 ranges each. The LR-204 from 20 milliohms to 2000 ohms (resolution 10 micro-ohms). The LR-205 from as low as 2 milliohms to 200 ohms (resolution 1 micro-ohm).

Here is the combination of features that make these micro-ohmmeters uncommon.

- Special circuit to negate those errors caused by pick-up in inductive components — automatically increasing versatility too.
- Pulse mode operation that conveniently holds readings and avoids the usual errors resulting from heating of the internal circuit/samples under measurement.
- B.C.D. output for systems capability.
- Sleek plastic casing that provides maximum protection and longer lasting good looks, with reduced size and weight.
- Quality that's exclusive, at a price that's not.

A system can be built around these instruments with the following optional accessories:

- A Digital limit comparator for quick go-no-go checks.
- A Digital printer for hard copy.
- A simple quick mate jig for speedy G.C. tests.

- When buying a Micro-ohmmeter you really have just 2 options. And they are both great!



For further details write to  
**THE MOTWANE MANUFACTURING COMPANY PVT. LTD.**, at Gyan Baug, Nasik Road 422 101 Tel.: 86297/86084  
 Telex: 752-247 MMPL IN Grams: MOTWANE or Gyan Ghar, Plot 434 A, 14th Road, Khar, Bombay- 400 052. Grams: MOTESTEM.

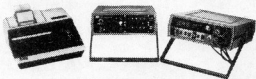

Cut here and mail

Please send literature and quotation on your LR Series

Name \_\_\_\_\_  
 Designation \_\_\_\_\_  
 Company \_\_\_\_\_  
 Address \_\_\_\_\_  
 Telephone \_\_\_\_\_ Telex \_\_\_\_\_

SELL ADS/MMC 1284

## New Kits

### Portable Guitar Amplifier

Project published in *elektor india* Feb. 1985  
Kit for Rs. 380.00

### 30 Watts A.F. Output Stage

Project published in *elektor india* Feb. 1985  
Kit for Rs. 400.00

### Function Generator

Project published in *elektor india* Jan. 1985 Generates sine, triangle and square waves. Frequency range 1 Hz to 110 KHz, divided into five decades.  
Kit for Rs. 850.00

## Other Popular Kits

### Musical Doorbells

All four types of musical doorbell kits for projects published in *elektor india* Aug/Sep. 1984, using ICs UM 3481, UM 3482, UM 3483 and UM 3484.  
Kit of each type for Rs. 105.00

### 100 Watts Guitar Amplifier

High quality transistorised power amplifier, having continuous 100 W output at 4 ohms load. Input impedance 3.9 K. Frequency Response 50 Hz—20 Hz ( $\pm 1$ dB), 20 Hz—150 KHz ( $\pm 3$  dB). Supply voltage  $\pm 40$  V.  
Kit for Rs. 400.00

### Stereo Graphic Equaliser

10 Bands per channel.  
Frequency response 10 Hz to 20 KHz. (Equaliser with all controls at zero.) Range  $\pm 13$  dB  
Kit for Rs. 800.00 Limited Stock:

Please refer to our advertisement in *elektor india* December 1984 for more details.

Please note : Graphic Equaliser Kit announced in *elektor india* Feb. 1985 is for one channel (mono) only.

## Semiconductors In Ready Stock

741	6.00
741 TO5	14.00
723 DIL	12.00
723 TO5	16.00
555	7.00
BEL 700	12.00
CA 3028	35.00
TLO 61	45.00
ULN 2003	35.00
LM 308	18.00
LM 348	30.00
LM 346	35.00
LM 358	18.00
LM 380	30.00
LM 381	35.00
LM 382	30.00

LM 386	20.00
LM 389	22.00
LM 390	35.00
LM 391	35.00
LM 748	15.00
LM 301	10.00
LM 317 T	25.00
LM 324	12.00
LM 339	12.00
LM 377	45.00
LM 710	16.00
LM 379 S	65.00
LM 1458	10.00
LM 1818	65.00
LM 3900	10.00
LM 3914	65.00

LM 3915	65.00
NM 5387	50.00
NM 5402	45.00
$\mu$ AA 170	35.00
$\mu$ AA 180	45.00
7106	130.00
7107	140.00
3½ digit LCD display	110.00
7400	7.00
7402	7.00
7492	18.00
7413	12.00
7447	20.00
7490	15.00
7493	15.00
MM 7317	65.00

**VISHA**  
ELECTRONICS

17, Kalpana Building  
349, Lamington Road,  
BOMBAY-400 007.

Telex: 362650

### TERMS:

- Goods by return post subject to availability.
- Special prices for volume order.
- Minimum outstation orders Rs. 50.00
- All orders must carry a minimum advance of 50%. balance payment by VPP or through Bank. (No cheque payment.)
- Prices are subject to change without any prior notice, will be charged as prevailing on date of despatch of goods.
- All prices are exclusive of M.S.T. and Postage.

**3324** **COSMIC**  
**COLOURVISION**

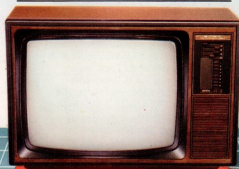

**COSMIC** COLOURVISION 3324  
offers colour with style.  
with its built in electronic tuner

Three decades in the field of electronics has helped Cosmic in creating an Audio-Visual marvel

- 51 cms. The carefully manufactured multifunction unit
- High intensity picture tube offers vibrant colours with perfect sound.
  - 8 mode channel selector.
- Matches any Video system-UHF or VHF

**Off with flying colours**